

Beta *Action*



INDUSTRY & HANDICRAFT

Promotion valid from 03/03/2025 to 29/08/2025
Prices do not include V.A.T.

€

1/2

Beta

RS050 2.0

WORK



**Configure
your workshop
in 3D online**

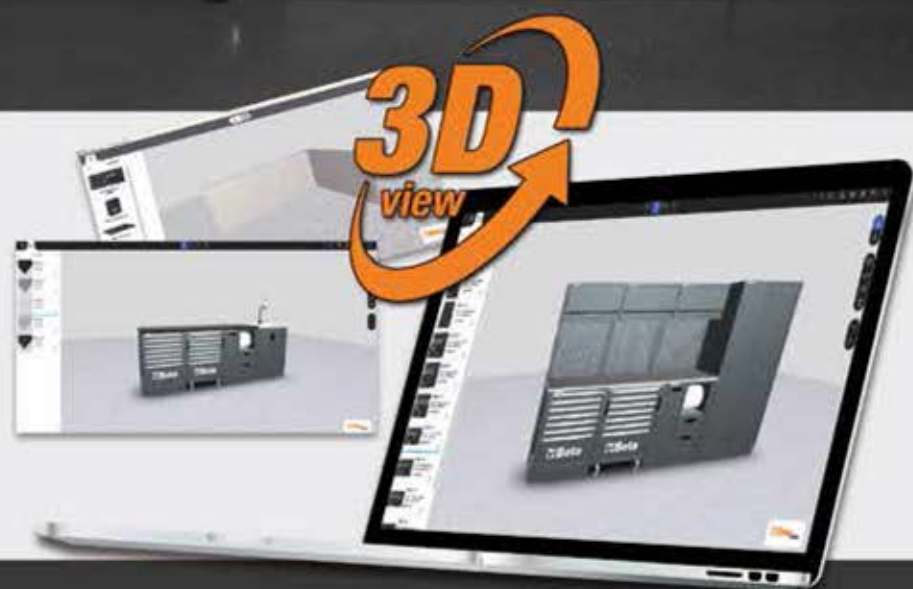

WORKSHOP EQUIPMENT
2÷5

CONTAINERS
6÷11

ASSORTMENT AND THERMOFORMED TRAYS
12÷15

WORKBENCHES
16÷18

TROLLEYS AND TOOL BOXES
19÷21

TOOL BAGS
22÷24

WRENCHES
25÷29

COLOR CODE
30

SCREWDRIVERS
31-32

SOCKETS
33÷36

TORQUE WRENCHES
37÷39

PLIERS
40÷42

DRILLING AND THREADING TOOLS
43-44

MEASURING TOOLS
45÷47

HAMMERS AND CHISELS
48

EXTRACTORS
49

PLUMBING TOOLS
50

LIGHTING
51÷55

GENERAL MAINTENANCE
56

BM
57

CUTTING TOOLS
58-59

REELS
60-61

1000V INSULATED TOOLS
62

INOX
63

BETA CHEMICALS
64÷65

AUTOMOTIVE
66-68

ROBUR
69÷72

PNEUMATIC TOOLS
73÷78

SAFETY FOOTWEAR
80÷87

WORKWEAR
88÷95

BETA COLLECTION
96

Blister pack support

RSC50 2.0

NEW!



**100%
MADE
By
Beta**

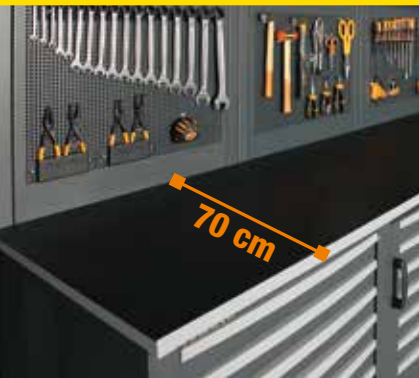

The workshop equipment combination, RSC50, has been upgraded into the new, **revolutionary RSC50 2.0**, with a **NEW 70-CM-DEEP WORKTOP**, for a large, convenient, functional work surface. It can be fitted with a vice, thereby allowing heavy-duty jobs to be carried out.

COMBINATION RSC50 2.0 D

+ Included in the price assortment of 224 TOOLS **Beta net value 1.429 €**

RSC50 2.0 D/224UT

050001090 276 kg

Workshop equipment combination RSC50 2.0 with 224 tools

Combination comprising the following:

- 1 worktop, 1,495x**700 mm** (RSC50 2.0 NPG/2-1.5MT)
- 1 fixed module with 7 drawers (RSC50 2.0 M7)
- 1 fixed two-door module (RSC50 2.0 MA)
- 2 wall-mounted cabinets (RSC50 2.0 PM)
- 2 upper perforated tool panels (RSC50 2.0 PFS)
- 2 lower perforated tool panels (RSC50 2.0 PFI)
- 2 pairs of right/left uprights (RSC50 2.0 P/2MDX-SX)
- 1 single-door tool cabinet (RSC50 2.0 A1)

~~9.980,00 €~~
3.790,00 €



M391

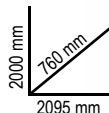

M392



M394



M395



GET A NEW LOOK!

RENOVATE YOUR WORKSHOP
**PURCHASE THE RSC50 2.0 D
 OR RSC50 2.0 F COMBINATION**

...Beta WILL TAKE CARE OF THE TOOLS!

COMBINATION RSC50 2.0 F

RSC50 2.0 F/411UT

050001095 411 kg

Workshop equipment combination RSC50 2.0 with 411 tools

Combination comprising the following:

- 1 worktop, 2,240x700 mm (RSC50 2.0 NPG/3-2.2MT)
- 1 fixed module with 7 drawers (RSC50 2.0 M7)
- 1 mobile roller cab with 7 drawers (RSC50 2.0 C7)
- 1 fixed service module with 2 drawers (RSC50 2.0 MS-2C)
- 3 wall-mounted cabinets (RSC50 2.0 PM)
- 3 upper perforated tool panels (RSC50 2.0 PFS)
- 3 lower perforated tool panels (RSC50 2.0 PFI)
- 3 pairs of right/left uprights (RSC50 2.0 P/2MDX-SX)
- 1 two-door tool cabinet (RSC50 2.0 A2)



Included in the price assortment of

411

TOOLS Beta

net value

2.199 €



~~16.940,00 €~~
5.999,00 €

2000 mm
 3155 mm
 760 mm

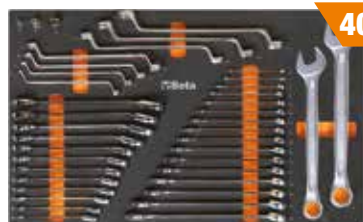

40

M25



116

M105

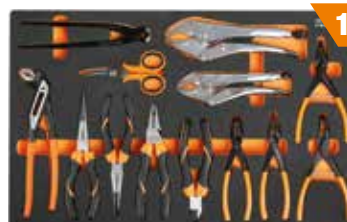

13

M169

14"

38"

12"



62

M229



34

M238



146

M320

The only soft foam tray with the new **IMPACT DRILL 20V** supplied with accessories and **2 batteries 4Ah**

C45PRO 2.0

NEW!



C45PRO 2.0 D

Workshop equipment combination C45PRO 2.0 comprising:

- 1 fixed module with 7 drawers (C45PRO 2.0 M7)
- 1 mobile roller cab with 7 drawers (C45PRO 2.0 C7)
- 1 fixed service module (C45PRO 2.0 MS)
- 1 fixed module with 5 drawers (C45PRO 2.0 M5)
- 1 fixed two-door module (C45PRO 2.0 MA)
- 5 perforated tool panels (C45PRO 2.0 PF)
- 5 wall-mounted cupboards (C45PRO 2.0 PM)
- 7 wall brackets, wide type (C45PRO 2.0 SL)
- 2 wall brackets, narrow type (C45PRO 2.0 SS)
- 2 single-door cabinets (C45PRO 2.0 AS1)

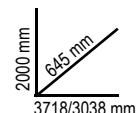

C45PRO 2.0 DX

11.570,00 €

5.929,00 €

045002031

640 kg

- 1 stainless steel coated MDF worktop, dimensions 2,040x**615** mm (C45PRO 2.0 PXE/3-2.0MT)
- 1 stainless steel coated MDF worktop, dimensions 1,360x**615** mm (C45PRO 2.0 PXE/2-1.3MT)
- 1 self-supporting complete corner with stainless steel coated MDF worktop (C45PRO 2.0 CORNER/X)



C45PRO 2.0 DW

11.280,00 €

5.929,00 €

045002032

606 kg

- 1 multi-ply wood worktop, dimensions 2,040x**615** mm (C45PRO 2.0 PWE/3-2.0MT)
- 1 multi-ply wood worktop, dimensions 1,360x**615** mm (C45PRO 2.0 PWE/2-1.3MT)
- 1 self-supporting complete corner with multi-ply wood worktop (C45PRO 2.0 CORNER/W)



C45PRO 2.0 A

Workshop equipment combination C45PRO 2.0

- Fixed service module (C45PRO 2.0 MS)
- Fixed module with 7 drawers (C45PRO 2.0 M7)
- Fixed two-door module (C45PRO 2.0 MA)
- 3 wall-mounted cabinets (C45PRO 2.0 PM)
- 3 perforated tool panels (C45PRO 2.0 PF)
- 2 wall brackets, narrow type (C45PRO 2.0 SS)
- 2 wall brackets, wide type (C45PRO 2.0 SL)

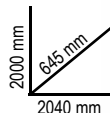

C45PRO 2.0 AX

4.040,00 €

2.079,00 €

045002003

234,5 kg

- Stainless steel coated MDF worktop, dimensions 2,040x**615** mm (C45PRO 2.0 PXE/3-2.0MT)



C45PRO 2.0 AW

3.930,00 €

2.079,00 €

045002004

219 kg

- Multi-ply wood worktop, dimensions 2,040x**615** mm (C45PRO 2.0 PWE/3-2.0MT)



NEW!



The workshop equipment system, C45PRO 2.0, has been upgraded into the C45PRO 2.0 system, an even more convenient one, **BASED ON THE NEW 61.5-CM DEEP WORKTOP** to answer the most demanding professionals' requirements.



CONVENIENT AND PROFESSIONAL

C45PRO 2.0

Workshop equipment combination C45PRO 2.0

- Fixed module with 7 drawers (C45PRO 2.0 M7)
- Mobile roller cab with 7 drawers (C45PRO 2.0 C7)
- Fixed service module (C45PRO 2.0 MS)
- 3 perforated tool panels (C45PRO 2.0 PF)
- 3 wall-mounted cabinets (C45PRO 2.0 PM)
- 3 wall brackets, wide type (C45PRO 2.0 SL)
- 1 wall bracket, narrow type (C45PRO 2.0 SS)
- Two-door cabinet (C45PRO 2.0 AS2)



C45PRO 2.0 X

045002001

5.760,00 €

3.069,00 €

334 kg



- Stainless steel coated MDF worktop, dimensions 2,040x**615** mm (C45PRO 2.0 PXE/3-2.0MT)

C45PRO 2.0 W

045002002

5.650,00 €

3.069,00 €

318 kg



- Multi-ply wood worktop, dimensions 2.040x**615** mm (C45PRO 2.0 PWE/3-2,0MT)

C45PRO 2.0 B

Workshop equipment combination C45PRO 2.0

- Fixed module with 5 drawers (C45PRO 2.0 M5)
- Fixed two-door module (C45PRO 2.0 MA)
- 2 wall-mounted cabinets (C45PRO 2.0 PM)
- 2 perforated tool panels (C45PRO 2.0 PF)
- 2 wall brackets, wide type (C45PRO 2.0 SL)
- 1 wall bracket, narrow type (C45PRO 2.0 SS)
- Single-door cabinet (C45PRO 2.0 AS1)

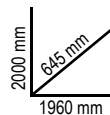

C45PRO 2.0 BX

045002021

3.620,00 €

1.859,00 €

206 kg



- Stainless steel coated MDF worktop, dimensions 1,360x**615** mm (C45PRO 2.0 PXE/2-1.3MT)

C45PRO 2.0 BW

045002022

3.510,00 €

1.859,00 €

196 kg



- Multi-ply wood worktop, dimensions 1,360x**615** mm (C45PRO 2.0 PWE/2-1.3MT)



DISCOVER THE RSC RANGE! THE EVOLUTION OF PERFECTION!



The **RSC range** has been designed to satisfy all professionals' requirements and ensure reliability as well as high operation performance. The innovative design, inspired by the racing world, provides these mobile roller cabs and trolleys with a captivating, unique style: the 7 colours and its finish make the RSC range synonymous with one-of-a-kind products in the market. The sturdy frameworks and the materials result in high quality and remarkable durability, thereby effectively supporting the daily work of industrial production departments, mechanics, car body repairers and general maintenance service providers. What is more, most RSC roller cabs are TÜV certified. This prestigious certification - which is the name for safety and guaranteed quality - is obtained upon successful completion of severe tests under the EK5/TA5 protocol.



RSC24

Mobile Roller cab

- ABS reinforced worktop
- Multi-purpose top with anti-fall edges and eight holes for accommodating screwdrivers
- Drawer bases protected by foamed rubber mats
- 4 castors Ø 125 mm: 2 fixed and 2 steering (one with brake)
- Each drawer can accommodate up to 4 EVA foam or ABS thermoformed trays
- Front centralized safety lock
- Static load capacity: 800 kg
- Built-in bottle holder (can be applied on both sides).

The following accessories can be added:

- Wood worktop 2400 RSC24/PL
- Perforated tool panel 2400 RSC24/PF
- Folding shelf 2400 RSC24/MP
- Document holder 2400 RSC24/PD
- Paper roll holder 2400 RSC24/PC
- Computer wall bracket 2400 RSC24/SPC



	Ral 2011	Ral 2011 Ral 7016	Ral 9006 Ral 7016	Ral 3000 Ral 7016	Ral 5015 Ral 7016	Ral 7016	Ral 9005	kg	€
RSC24/5	024004050	024004051	024004052	024004053	024004056	024004057	024004059	60	1.044,00 € 571,00 €
RSC24/6	024004060	024004061	024004062	024004063	024004066	024004067	024004069	62	1.124,00 € 637,00 €
RSC24/7	024004070	024004071	024004072	024004073	024004076	024004077	024004079	63	1.210,00 € 681,00 €
RSC24/8	024004080	024004081	024004082	024004083	024004086	024004087	024004089	66	1.305,00 € 736,00 €

RSC24/5		
n°	Max	Max
2	70 mm	25 kg
2	140 mm	30 kg
1	280 mm	35 kg

RSC24/6		
n°	Max	Max
4	70 mm	25 kg
1	140 mm	30 kg
1	280 mm	35 kg

RSC24/7		
n°	Max	Max
5	70 mm	25 kg
1	140 mm	30 kg
1	210 mm	30 kg

RSC24/8		
n°	Max	Max
6	70 mm	25 kg
2	140 mm	30 kg

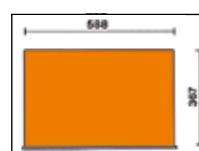

THE MOST COMPLETE  **Beta**
ASSORTMENT EVER

**AND THE ROLLER CAB RSC24
IS INCLUDED IN THE PRICE!**

Save up to
3.800,00 €

2400 RSC24/7-VIS

024004037

~~3.420,00 €~~

ASSORTMENT OF 224 TOOLS FOR INDUSTRIAL MAINTENANCE



M391



M392

1.429,00 €

INDUSTRIAL MAINTENANCE 14" 12"
Medium version



M394



M395



**INCLUDED:
Mobile
roller cab with
RSC24/7-FO**

7 removable drawers (588x367 mm),
with ball bearing slides
• 5 drawers, 70 mm high
• 1 drawer, 140 mm high
• 1 drawer, 210 mm high

Promotion valid only with RSC24 FULL ORANGE

2400 RSC24A/8-VIL

024004008

~~6.000,00 €~~

ASSORTMENT OF 411 TOOLS FOR INDUSTRIAL MAINTENANCE



M25



M105

2.199,00 €

INDUSTRIAL MAINTENANCE 14" 38" 12"
Extra large version



M169



M229

**THE MOST COMPLETE
BETA ASSORTMENT EVER**



M238



M320



**INCLUDED:
Mobile
roller cab with
anti-tilt system
RSC24A/8-O**

8 removable drawers
(588x367 mm), with
ball bearing slides
• 6 drawers, 70 mm high
• 2 drawers, 140 mm high

Promotion valid only with RSC24 ORANGE

The only soft foam tray with the new
IMPACT DRILL 20V supplied with
accessories and **2 batteries 4Ah**

RSC24AXLP/7

105 Kg

Mobile roller cab with 7 drawers, with wood worktop and ANTI-TILT SYSTEM, long model

- Long model with 7 fully removable drawers (882x367 mm), with ball bearing slides
- Multi-ply wood worktop with holes for a vice 1599F/100 or 1599GI/100 (to be ordered separately)
- Sturdy nylon front, with built-in label holder
- Drawer bases protected by foamed rubber mats
- 4 castors, Ø 125 mm: 2 fixed and 2 steering (one with brake)
- Front centralized safety lock
- Built-in side bottle holder (can be applied on both sides)
- Built-in paper roll holder
- Each drawer can accommodate up to **6 EVA foam or ABS thermoformed trays**

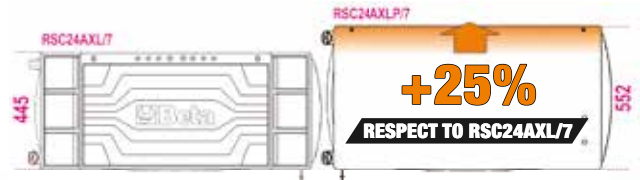

Ral 2011	Ral 3000	Ral 7016
Ral 7016	Ral 7016	Ral 7016
024004571	024004573	024004577

1.955,00 €
1.099,00 €



n°	Height	Max
5	70 mm	30 kg
1	140 mm	35 kg
1	210 mm	35 kg



RSC24L-CAB

82 Kg

Mobile roller cab with 7 drawers and tool cabinet

- 7 drawers (588x367 mm) with ball bearing slides:
 - 5 drawers, 70 mm high
 - 1 drawer, 140 mm high
 - 1 drawer, 210 mm high.
- Drawer bases protected by foamed rubber mats.
- 4 castors, Ø 125 mm: 2 fixed and 2 steering with brakes.
- Front centralized lock.
- **Side tool cabinet with lockable door and vertically adjustable interior shelf.**
- Static load capacity: 1.100 kg.
- Multi-ply wood worktop with holes for a vice (1599F/100, to be ordered separately).
- Built-in paper roll holder.
- Double rear bottle holder.
- Built-in side bottle holder

1000

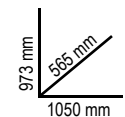

Ral 2011	Ral 3000	Ral 7016
Ral 7016	Ral 7016	Ral 7016
024004471	024004473	024004477

1.908,00 €
1.066,00 €

n°	Height	Max
5	70 mm	25 kg
1	140 mm	30 kg
1	210 mm	30 kg

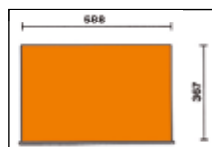

RSC24AXL

Mobile roller cab, WITH ANTI-TILT SYSTEM, long model

- New ABS reinforced worktop with anti-fall edges, eight holes for accommodating screwdrivers and 6 tote trays
- Sturdy nylon front, with built-in label holder.
- Drawer bases protected by foamed rubber mats
- 4 castors, Ø 125 mm: 2 fixed and 2 steering (one with brake)
- Front centralized safety lock
- Built-in side bottle holder (can be applied on both sides)
- Each drawer can accommodate up to 6 EVA foam or ABS thermoformed trays

Following accessories can be added:

- Wood worktop 2400 RSC24/PL
- Document holder 2400 RSC24/PD-A
- Paper roll holder 2400 RSC24/PC-A

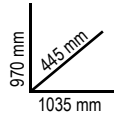

	Ral 2011 Ral 7016	Ral 3000 Ral 7016	Ral 7016	n°	max	kg	€
RSC24AXL/7	024004271	024004273	024004277	5	70 mm	30 kg	1.700,00 € 967,00 €
				1	140 mm	35 kg	
				1	210 mm	35 kg	
RSC24AXL/8	024004281	024004283	024004287	6	70 mm	30 kg	1.820,00 € 1.033,00 €
				2	140 mm	35 kg	
RSC24AXL/9	024004291	024004293	024004297	8	70 mm	30 kg	1.935,00 € 1.099,00 €
				1	140 mm	35 kg	

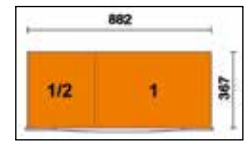

RSC24AXXL

131 kg

~~2.420,00 €~~
1.379,00 €

NEW!

Mobile roller cab with 8 drawers and anti-tilt system, long model

- 1 fully removable drawer (1,176x367 mm), with ball bearing slides
- 7 fully removable drawers (882x367 mm), with ball bearing slides:
 - 6 drawers 70 mm high
 - 1 drawer 140 mm high
- Worktop made from stainless steel coated MDF, with holes for vice item 1599F/125 or 1599GI/125 (to be ordered separately) and 6 tote trays
- Sturdy nylon fronts, with built-in label holders
- Drawer bases protected by foamed rubber mats
- Removable side compartment, with ball bearing slides, with shelf and lock
- 4 castors, Ø 150 mm: 2 fixed and 2 steering with brakes
- 3 safety locks
- Built-in paper roll holder
- Built-in bottle holder
- Static load capacity: 1,100 kg
- Following trays can be added:
 - up to 8 EVA foam or ABS thermoformed trays in drawer 1,176x367 mm
 - up to 6 EVA foam or ABS thermoformed trays in drawer 882x367 mm



n°	Max
1	70 mm (1.176x367 mm) 40 kg
6	70 mm (882x367 mm) 30 kg
1	140 mm (882x367 mm) 35 kg

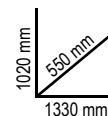

Ral 2011 Ral 7016	Ral 3000 Ral 7016	Ral 7016
024004781	024004783	024004787



RSC28

130 Kg

SuperTank trolley with wood worktop and 10 drawers

- 10 drawers (588x367 mm) with ball bearing slides
- Quick, safe system for opening and closing drawers, with nylon and fibreglass front
- **5 side drawers:**
4 drawers, 70 mm high
1 drawer, 210 mm high
- **5 front drawers:**
4 drawers, 70 mm high
1 drawer, 210 mm high
- Drawer bases protected by foamed rubber mats.
- 4 high-capacity castors, Ø 150 mm: 2 fixed and 2 steering with brakes
- 2 centralized safety locks
- 3 front tool drawers
- Multi-ply wood worktop with holes for a vice (1599F/150 - 1599GI/150, to be ordered separately)
- Built-in tool compartment

kg
1200



- Side compartment with foldaway door with lock
- Built-in bottle holders
- 135-mm-high storage compartment with plastic-covered base



Ral 2011	Ral 3000	Ral 7016
Ral 7016	Ral 7016	Ral 7016

028003001 028003003 028003007

3.330,00 €
1.847,00 €

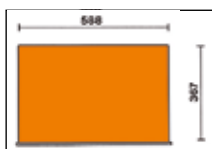

n°	h	Max
8	70 mm	25 kg
2	210 mm	30 kg

C30M

030000300

200 kg

5.320,00 €
2.199,00 €

MaxiTank mobile workbench

- 5 front drawers with ball bearing slides:
3 drawers (367x610 mm), 90 mm high
1 drawer (588x610 mm), 90 mm high
1 drawer (588x610 mm), 180 mm high.
- Quick opening system with aluminium front.
- Drawer bases protected by foamed rubber mats.
- Can be fitted with thermoformed trays.
- One hydraulic jack, designed to lift front part effortlessly, thus allowing easy transportation.
- 4 high-capacity castors: 2 steering, front, Ø 150 mm² fixed, rear, Ø 170 mm.
- Oil-proof, rubber-coated worktop, 1300x800 mm, with drain hole for fluid collection in a small tank.
- Storage compartment, 720x250x1300 mm, with PVC-coated worktop and front sliding panels.
- Centralized lock for drawers and panels.
- 3 built-in side bottle holders.
- Built-in paper roll holder
- Static load capacity: 1.800 kg.
- Can accommodate a multi-ply wood worktop (3000M/PLM), to be ordered separately
- Can accommodate vice 1599F/150 or 1599GI/150 (to be ordered separately).

kg
1800

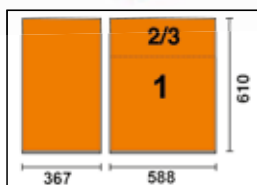
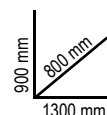

h	max
90 mm	30 kg
180 mm	35 kg



MOBILE ROLLER CAB + ASSORTIMENT 181 TOOLS

3900 07/5M

039000371  71 Kg

5.210,00 €
2.529,00 €

Mobile roller cab C39 with 7 drawers

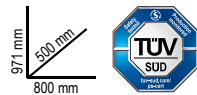

3700 07/5M

037000371  61 Kg

4.470,00 €
2.079,00 €

Mobile roller cab C37 with 7 drawers

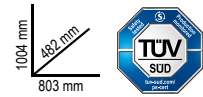

M01

 4,5 Kg

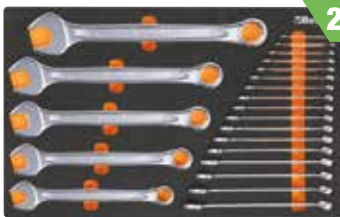

22



42 6-7-8-9-10-11-12-13-14
15-16-17-18-19-20-21-22
24-27-30-32-36 mm

M60

 1,9 Kg



23



○ 96T 2-2,5-3-4-5-6-7-8-10 mm
○ 97BTX/SC8 T9-T10-T15-T20
T25-T27-T30-T40
○ 944BX 5-6-7-8-10-13 mm

M213

 1,8 Kg



25



- 1201E 2,5x50-3x75-4x100-5,5x125-6,5x150-8x200 mm
- 1201EN 4x30 mm
- 1202E PH0x60-PH1x80-PH2x100-PH3x150 mm
- 1202EN PH1X30 mm
- 1207E/TX T6-T7-T8-T9-T10-T15-T20-T25-T27-T30-T40-T45
- 1253 3,5x100 mm

M129

 3,4 Kg



13



- 1032 180 mm
- 1034 170 mm
- 1036 175 mm
- 1038 175 mm
- 1048N 250 mm
- 1052 240 mm
- 1082BM 160 mm
- 1098 220 mm
- 1112 250 mm
- 1128BM
- 1150BM 180 mm
- 1166BM 160 mm
- 1168BM 160 mm

M100

 6,7 Kg



98

- 895/1 - 895/3 - 895/6
- 900 4,4-5-5,5-6-7-8-9-10-11-12-13-14 mm
 - 900L 5-6-7-8-9-10-11-12-13 mm
 - 900ME 3-4-5-6-7 mm
 - 900LP 0,8x4-1x5,5-1,2x6,5-1,2x8 mm
 - 900PH PH1-PH2-PH3-PH4
 - 900TX T10-T15-T20-T25-T27-T30-T40

- 900/20 50 mm - 900/20L 100 mm
- 900/21 150 mm
 - 900/25
 - 900BG/30
 - 900/42
 - 900/55
 - 920A 8-10-11-12-13-14-15-16-17-18-19-20-21-22-23-24-26-27-28-30-32 mm

- 920/15 - 920/25
- 920AN/125 125 mm
 - 920AN/250 250 mm
 - 920/42
 - 920/55
 - 920FTX 10-12-14-16-18-20-22-24 mm
 - 920AL 10-12-13-14-15-16-17-18-19-21-22 mm

1/4" 1/2"



5988VU/M 3.520,00 €
1.969,00 €
 059880356 30 Kg



Assortment of 214 tools in soft foam tray

Recommended with: RSC24 - RSC24A - RSC24AXL - RSC24AXLP/7 - RSC24AXL - C37 - C39 - C39SM - C39MD - C58BC - RSC28 - C59 - RSC55 - RSC50 2.0

Quantity/Description	Beta N.	TR
22 combination wrenches 6-7-8-9-10-11-12-13-14-15-16-17-18-19-20-21-22-24-27-30-32-36 mm	42	M01
11 double open end wrenches 6x7-8x9-10x11-12x13-14x15-16x17-18x19-20x22-21x23-24x27-30x32 mm	55	M30
11 double ended offset ring wrenches 6x7-8x9-10x11-12x13-14x15-16x17-18x19-20x22-21x23-24x27-30x32 mm	90	M30
9 ball head offset hexagon key wrenches \odot 1,5+10 mm	96BPC/SC9	M30
1 socket holder	895/1	M100
1 socket holder	895/3	M100
1 socket holder	895/6	M100
13 1/4" hexagon sockets \odot 4-4,5-5-5,5-6-7-8-9-10-11-12-13-14 mm	900	M100
9 hexagon hand sockets, long series \odot 5-6-7-8-9-10-11-12-13 mm	900L	M100
5 1/4" socket drivers for hexagon screws \odot 3-4-5-6-7 mm	900ME	M100
4 socket drivers for slotted head screws \bullet 0,8x4-1x5,5-1,2x6,5-1,2x8 mm	900LP	M100
4 socket drivers for cross head Phillips® screws \bullet PH1-PH2-PH3-PH4	900PH	M100
7 socket drivers for Torx® head screws \bullet T10-T15-T20-T25-T27-T30-T40	900TX	M100
1 1/4" drive extension bar 50 mm	900/20	M100
1 1/4" drive extension bar 100 mm	900/20L	M100
1 1/4" drive extension bar 150 mm	900/21	M100
1 1/4" drive universal joint	900/25	M100
1 1/4" drive spinner handle	900BG/30	M100
1 1/4" drive swivel T-handle	900/42	M100
1 1/4" reversible ratchet \oplus	900/55	M100
21 1/2" square drive hexagon sockets \odot 8-10-11-12-13-14-15-16-17-18-19-20-21-22-23-24-26-27-28-30-32 mm	920A	M100
1 adaptor, 1/2" female and 3/8" male drives 125 mm	920/15	M100
1 1/2" drive universal joint 250 mm	920/25	M100
1 1/2" wobble extension bar 125 mm	920AN/125	M100
1 1/2" wobble extension bar 250 mm	920AN/250	M100
1 1/2" drive sliding T-handle 305 mm	920/42	M100
1 1/2" drive reversible ratchet \oplus	920/55	M100
8 1/2" sockets for Torx® head screws \bullet 10-12-14-16-18-20-22-24 mm	920FTX	M100
11 hexagon hand sockets \odot 10-12-13-14-15-16-17-18-19-21-22 mm	920AL	M100
1 circlip pliers straight, internal \odot 180 mm	1032	M129
1 circlip pliers bent, internal \odot 170 mm	1034	M129
1 circlip pliers straight, external \bullet 175 mm	1036	M129
1 circlip pliers bent, external \bullet 175 mm	1038	M129
1 slip joint pliers 250 mm	1048N	M129
1 self - locking pliers 240 mm	1052	M129
1 Diagonal cutting nippers \nless 160 mm	1082BM	M129
1 construction worker's pincers 220 mm	1098	M129
1 tin snips 250 mm	1112	M129
1 electrician's scissors, straight blades	1128BM	M129
1 half-round needle nose pliers \equiv 180 mm	1150BM	M129
1 Extra-long needle nose pliers \bullet 160 mm	1166BM	M129
1 Extra-long bent needle nose pliers \bullet 160 mm	1168BM	M129
6 screwdriver for slotted head screws \bullet 2,5x50-3x75-4x100-5,5x125-6,5x150-8x200 mm	1201E	M213
1 screwdriver for slotted head screws, extra-short series \bullet 4x30 mm	1201EN	M213
4 screwdriver for cross head Phillips® screws \bullet PH0,60-PH1x80-PH2x100-PH3x150 mm	1202E	M213



M01



M30



M213



M230



M129



M100

- | | | |
|--|-------------|------|
| 1 screwdriver for cross head Phillips® screws, extra-short series \bullet PH1x30 mm | 1202EN | M213 |
| 12 screwdrivers for Torx® head screws, with handles \odot T6-T7-T8-T9-T10-T15-T20-T25-T27-T30-T40-T45" | 1207E/TX | M213 |
| 1 mains testing screwdriver \bullet | 1253 | M213 |
| 3 drift punches 2-3-4 mm | 30 | M230 |
| 6 pin punches 2-3-4-5-6-8 | 31 | M230 |
| 1 centre punch \varnothing 4 mm | 32 | M230 |
| 1 flat chisels 150 mm | 34 | M230 |
| 2 flat chisels, ribbed type 200-250 mm | 35 | M230 |
| 1 cape chisels, standard type 125 mm | 36 | M230 |
| 1 engineer's hammer 500 g | 1370 | M230 |
| 1 soft face hammer \varnothing 35 mm | 1390 | M230 |
| 1 measuring tape 3 m | 1692 | M230 |
| 1 telescopic magnet with flexible head | 1712TF | M230 |
| 1 second-cut square files 200 mm | 1719BMA...Q | M230 |
| 1 second-cut triangular files 200 mm | 1719BMA...T | M230 |
| 1 second-cut flat files 200 mm | 1719BMA...P | M230 |
| 1 second-cut half-round files 200 mm | 1719BMA...M | M230 |
| 1 second-cut round files 200 mm | 1719BMA...R | M230 |
| 1 steel wire brush | 1737NX | M230 |
| 1 snap - off blade utility knife 18 mm | 1771 | M230 |

5904VU/1M 1.585,00 €
824,00 €
 059041201 12 Kg



Assortment of 90 tools in soft foam tray

Recommended with: RSC23T - RSC24 - RSC24A - RSC24AXL - RSC24AXLP/7 - RSC24AXL - RSC24L/7 - RSC24L-CAB - RSC28 - C37 - C39 - C39T - C39SM - C39MD - RSC51 - RSC55 - RSC50 2.0 - C59 - C58BC

Quantity/Description	Beta N.	TR
16 combination wrenches 6+21 mm	42	M05
8 double open end wrenches 6x7-8x9-10x11-12x13-14x15-16x17-18x19-20x22 mm	55	M33
9 offset hexagon key wrenches \odot 1,5-2-2,5-3-4-5-6-8-10 mm	96/SC9	M33
6 drivers for Torx® head screws \odot T8-T10-T15-T20-T25-T30	1267TX	M204
3 screwdrivers for slotted head screws \bullet 3x75-4x100-6,5x150 mm	1260	M201
3 screwdrivers for cross head Phillips® screws \bullet PH0x60-PH1x80-PH2x100 mm	1262	M201
8 offset hexagon key wrenches \odot 2-2,5-3-4-5-6-7-8 mm	96T	M50
1 1/2" wobble extension bar 125 mm	920AN/125	M83
1 1/2" wobble extension bar 250 mm	920AN/250	M83
1 1/2" drive universal joint	920/25	M83
1 1/2" drive sliding T-handle	920/42	M83
1 1/2" drive reversible ratchet \oplus	920/55	M83
19 1/2" square drive hexagon sockets \odot 10+24-26-27-30-32 mm	920A	M83
1 Heavy-duty diagonal cutting nippers \nless 160 mm	1084	M137
1 combination pliers bright chrome-plated \equiv 180 mm	1150	M137
1 Extra-long needle nose pliers \bullet 160 mm	1166	M137
1 slip joint pliers, slip-proof PVC coated handles 250 mm	1048N	M153
1 self - locking pliers 240 mm	1052	M153
2 flat chisels, ribbed type 100 - 200 mm	35	M234
1 engineer's hammer 300 g	1370	M234
1 soft face hammer \varnothing 35 mm	1390	M234
1 circlip pliers straight, internal \odot 180 mm	1032	M145
1 circlip pliers bent, internal \odot 170 mm	1034	M145
1 circlip pliers straight, external \bullet 175 mm	1036	M145
1 circlip pliers bent, external \bullet 175 mm	1038	M145



M05



M50



M137



M83



M153



M234



M145

NEW ONLINE CONFIGURATOR

Create your own roller cab with your favourite tools and accessories



M01 ~~497,80 €~~
289,00 €
 024500001 4,5 Kg

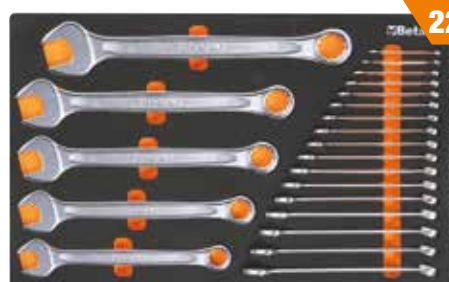

22

42 6-7-8-9-10-11-12-13-14-15-16-17-18
 19-20-21-22-24-27-30-32-36 mm

M25 ~~799,80 €~~
438,00 €
 024500025 5,1 Kg

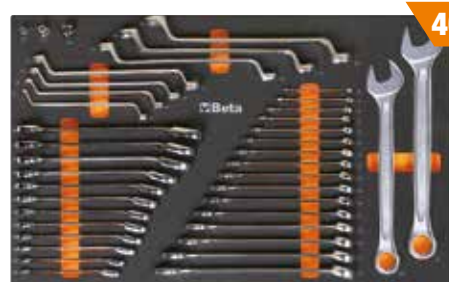

40

42 6-7-8-9-10-11-12-13-14-15-16-17-18-19-21-22-24-27 mm
 90 6x7-8x9-10x11-12x13-14x15-16x17-18x19 mm
 123Q1/4
 123Q3/8
 123Q1/2
 142 8-9-10-11-12-13-14-15-16-17-18-19 mm

M30 ~~463,80 €~~
268,00 €
 024500030 4,2 Kg



31

55 6x7-8x9-10x11-12x13-14x15-16x17-18x19-20x22-21x23-24x27-30x32 mm
 90 6x7-8x9-10x11-12x13-14x15-16x17-18x19-20x22-21x23-24x27-30x32 mm
 96BPC/SC9 1,5-2-2,5-3-4-5-6-8-10 mm

M60 ~~426,80 €~~
246,00 €
 024500060 1,9 Kg



23

○ 96T 2-2,5-3-4-5-6-7-8-10 mm
 ○ 97BTX/SC8 T9-T10-T15-T20-T25-T27-T30-T40 mm
 ○ 944BX 5-6-7-8-10-13 mm



M63 ~~387,80 €~~
227,00 €
 024500063 3,4 Kg



8

○ 952 7-8-10-12-13-14-17-19 mm

M100 ~~1.350,00 €~~
659,00 €
 024500100 6,7 Kg



98

14" 12"

895/1 - 895/3 - 895/6
 ○ 900 4-4,5-5-5,5-6-7-8-9-10-11-12-13-14 mm
 ○ 900L 5-6-7-8-9-10-11-12-13 mm
 ○ 900ME 3-4-5-6-7 mm
 ● 900LP 0,8x4-1x5,5-1,2x6,5-1,2x8 mm
 ● 900PH PH1-PH2-PH3-PH4
 ● 900TX T10-T15-T20-T25-T27-T30-T40
 900/20 50 mm - 900/20L 100 mm
 900/21 150 mm
 900/25
 900BG/30
 900/42

● 900/55
 ○ 920A 8-10-11-12-13-14-15-16-17-18-19-20-21-22-23-24-26-27-28-30-32 mm
 920/15 - 920/25
 920AN/125 125 mm
 920AN/250 250 mm
 920/42
 ● 920/55
 ● 920FTX 10-12-14-16-18-20-22-24 mm
 ○ 920AL 10-12-13-14-15-16-17-18-19-21-22 mm

M105 1.478,00€
714,00 €
024500871 7,7 Kg



116

14" 38" 12"

- 900 4-4,5-5-5,5-6-7-8-9-10
11-12-13-14 mm
- 900L 5-6-7-8-9-10-11-12-13 mm
- 96BPC/SC9 1,5-2-2,5-3-4-5-6-8-10 mm
- 895/1 - 895/3 - 895/6
- 900ME 3-4-5-6-7 mm
- 900LP 0,8x4-1x5,5-1,2x6,5-1,2x8 mm
- 900PH PH1-PH2-PH3-PH4
- 900TX T10-T15-T20-T25-T27-T30-T40
- 900/16 □ 1/4 - ■ 3/8
- 900/... 50-100-150 mm
- 900/25 - 900BG/30 - 900/42
- ⊗ 900/55
- 910A 6-7-8-9-10-11-12-13-14-15-16-17-18-19-20-21-22 mm
- 910/15 □ 3/8 - ■ 1/4
- 910/16 □ 3/8 - ■ 1/2
- 910/21 125 mm
- 910/22 250 mm
- 910/25 - 910/42
- ⊗ 910/55
- 920A 8-10-11-12-13-14-15-16-17-18-19-20-21-22-23-24-26-27-28-30-32 mm
- 920/15 □ 1/2 - ■ 3/8
- 920/25 125 - 250 mm
- 920AN
- 920/42
- ⊗ 920/55
- 956E 16-17,8-20,8 mm

M129 494,00€
296,00 €
024500129 3,4 Kg



13

- 1032 180 mm
- 1034 170 mm
- 1036 175 mm
- 1038 175 mm
- 1048N 250 mm
- 1052 240 mm
- 1082BM 160 mm
- 1098 220 mm
- 1112 250 mm
- 1128BM 145 mm
- 1150BM 180 mm
- 1166BM 160 mm
- 1168BM 160 mm

M213 245,00€
142,00 €
024500213 1,8 Kg



25

Betaevor

- 1201E 2,5x50-3x75-4x100-5,5x125-6,5x150-8x200 mm
- 1201EN 4x30 mm
- 1202E PH0x60-PH1x80-PH2x100-PH3x150 mm
- 1202EN PH1X30 mm
- 1207E/TX T6-T7-T8-T9-T10-T15-T20-T25-T27-T30-T40-T45
- 1253 3,5x100 mm

M118 1.113,00€
549,00 €
024500118 8 Kg

FOR 140 mm DRAWERS



33

12"



REVERSIBLE
IMPACT WRENCH
1927P

75

- 1927P 1750 Nm
- 720L ○ 13-17-19-21-22-24 mm
- 720ME ○ 5-6-8-10-12-14-17-19 mm
- 720 ○ 10-12-13-14-15-16-17-18-19-21-22-24-27-30-32 mm
- 720LC ○ 17-19-21 mm

M230 467,00€
270,00 €
024500230 3,2 Kg



25

- 30 Ø 2-3-4 mm
- 31 Ø 2-3-4-5-6-8 mm
- 32 Ø 4 mm
- 34 150 mm
- 35 200-250 mm
- 36 125 mm
- 1370 500 g
- 1390 Ø 35 mm
- 1692 3 m
- 1712TF
- 1719BMA/Q 200 mm
- ▲ 1719BMA/T 200 mm
- 1719BMA/P 200 mm
- ▶ 1719BMA/M 200 mm
- 1719BMA/R 200 mm
- 1737NX
- 1771 170 mm

M120 1.440,00€
714,00 €
024500120 6,9 Kg



75

12"

- 920A 10-11-12-13-14-15-16-17-18-19-20-21-22-24-26-27-30-32 mm
- 920AN/125 125 mm
- 920AN/250 250 mm
- 920/25 - 920/42
- 920AL 10-12-13-14-15-16-17-18-19-22-24-27-30-32 mm
- 920FTX 10-12-14-16-18-20-22-24 mm
- ⊗ 920/55
- 920PE 5-5L-6-6L-7-7L-8-8L-10-10L-12-12L-14-14L
- 920TX T20-T25-T27-T30-T40-T45-T50-T55-T60-T20L-T25L-T27L-T30L-T40L-T45L-T50L

M320 990,00€
494,00 €
024500320 5 Kg

NEW!

FOR 140 mm DRAWERS



146



IMPACT
DRILL 20V
1972/K20V

- 410MIX/SEL19
- 861/C100
- 862F/A7
- 862XP/A16
- 1972/K20V-13BMC

T01 ~~302,00 €~~
176,00 €
 024240001



42 6-7-8-10-11-12-13-14-16-17-18-19-21-22-24-27-30 mm

17 2,7 kg

T05 ~~230,00 €~~
134,00 €
 024240005



42 6-7-8-9-10-11-12-13-14-15-16-17-18-19-20-21 mm

16 1,5 kg

T06 ~~162,50 €~~
96,00 €
 024240006



42 22-24-27-30-32 mm

5 2,1 kg

T31 ~~247,50 €~~
145,00 €
 024240031



31 Ø 2-3-4-5-6 mm 32 Ø 4 mm
 55 6x7-8x9-10x11-12x13-14x15-16x17-18x19
 20x22-21x23-24x26-27x29-30x32 mm
 ○ 96N/SC9 1,5÷10 mm

27 3 kg

T45 ~~348,00 €~~
202,00 €
 024240045

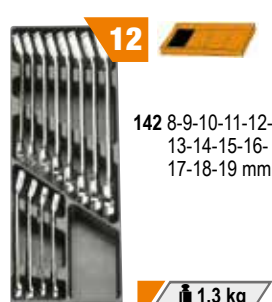

142 8-9-10-11-12-13-14-15-16-17-18-19 mm

12 1,3 kg

T50 ~~196,50 €~~
114,00 €
 024240050



○ 96T 2-2,5-3-3,5-4-4,5-5-6-7-8-10 mm

11 1,3 kg

T63 ~~377,00 €~~
219,00 €
 024240063



○ 952 7-8-10-12-13-14-17-19 mm

8 3,8 kg

T68 ~~160,50 €~~
91,00 €
 024240068



○ 951 2,5-3-4-5-6-8 mm

6 590 g

T80 ~~463,00 €~~
219,00 €
 024240080

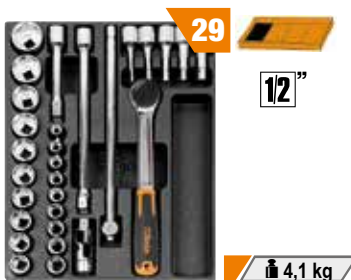

○ 920A 10-11-12-13-14-15-16-17-18-19-20-21-22-23-24-26-27-30-32 mm
 ○ 920ME 5-6-8-10-12 mm
 920/21 125 mm 920/22 255 mm
 920/25 - 920/42 305 mm ⊕ 920/55

29 4,1 kg

T91 ~~248,50 €~~
109,00 €
 024240091



○ 900 4-4,5-5-5,5-6-7-8-9-10-11-12-13-14 mm
 ○ 900ME 2,5-3-4-5-6-8 mm
 900/20 50 mm 900/21 150 mm
 900/25 - 900BG/30 - 900/42 115 mm ⊕ 900/55

25 560 g

T92 ~~284,00 €~~
120,00 €
 024240092



○ 910A 6-7-8-9-10-11-12-13-14-15-16-17-18-19-20-21-22 mm
 910/21 125 mm 910/42 210 mm
 910/22 250 mm ⊕ 910/55
 910/25

22 1,5 kg

T137 ~~128,50 €~~
74,00 €
 024240137



⊘ 1084BM 160 mm
 ⊕ 1150BM 180 mm
 ● 1166BM 160 mm

3 750 g

T145 ~~143,00 €~~
84,00 €
 024240145

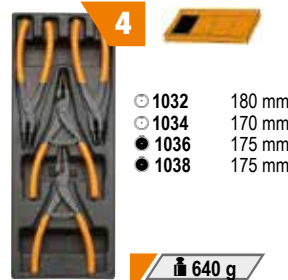

○ 1032 180 mm
 ○ 1034 170 mm
 ● 1036 175 mm
 ● 1038 175 mm

4 640 g

T221 ~~50,50 €~~
30,00 €
 024240221



● 1201E 3x75-4x100-5,5x150-6,5x150 mm
 ⊕ 1202E PH0x60-PH1x80-PH2x100 mm

7 530 g

T234 ~~110,00 €~~
65,00 €
 024240234



35 100-200 mm
 1370 300 g
 1390 ø 35 mm

4 1,3 kg

T236 ~~109,00 €~~
64,00 €
 024240236



■ 1719BMA/Q 200 mm
 ▲ 1719BMA/T 200 mm
 ▩ 1719BMA/P 200 mm
 ▸ 1719BMA/M 200 mm
 ● 1719BMA/R 200 mm

5 870 g

MODULAR

NEW RANGE OF WORKBENCHES

NEW!

Beta has launched the new range of workbenches, MODULAR, designed to make it possible for professionals to configure their workplaces from scratch, adapting them to their individual needs.

De reeks is verkrijgbaar in een ruime keuze aan voorgeselecteerde combinaties; u kunt uw configuratie ook volledig aanpassen, inclusief de werkbladen, poten, gereedschapswagens en gereedschapskisten, gereedschapswandsystemen en accessoires.



ROLLER CABS



WALL SYSTEM



LEGS



WORKTOP

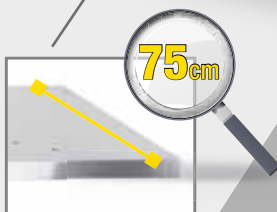

The 75-cm-deep worktop means having a large, convenient, functional work surface available. It can be fitted with a vice, thereby allowing heavy-duty jobs to be carried out.

The new MODULAR range, designed according to the latest ergonomics studies, is enhanced by Beta's well-known sturdiness and quality, thereby standing out as an essential work partner.



CONFIGURE YOUR **WORKSHOP ONLINE**
go to **www.beta-tools.com**

DISCOVER THE ONLINE CONFIGURATOR



C58BC-W2,1+SVR

- Worktop (2,100x750 mm) made from multi-ply wood, 38 mm thick
- Front centralized lock
- Steel frame with 4 supporting legs
- Holes for a vice (1599F/150 - 1599GI/150, to be ordered separately)
- 2 lower half-shelves for objects, 1,788x335 mm; thickness: 40 mm
- Static load capacity: 800 kg, evenly distributed
- Can be fixed to floor



C58BC-W2,1 4C+SVR

NEW!

146 Kg

Workbench, 2.1 m long, with wood worktop, with 4 drawers

- 4 drawers (367x588 mm) with ball bearing slides:
 - 2 drawers 70 mm high
 - 2 drawers 140 mm high.
- Drawer bases protected by foamed rubber mats

- Each drawer can accommodate up to 4 EVA foam or ABS thermoformed trays



Ral 2011	Ral 7016
058000723	058000727

2.045,00 €
1.099,00 €

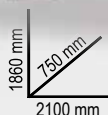

C58BC-W2,1 4CA+SVR

NEW!

161 Kg

Workbench, 2.1 m long, with wood worktop, 4 drawers and door module

- 1 module with door and lock
- 4 drawers (367x588 mm) with ball bearing slides:
 - 2 drawers 70 mm high
 - 2 drawers 140 mm high.
- Drawer bases protected by foamed rubber mats

- Each drawer can accommodate up to 4 EVA foam or ABS thermoformed trays



Ral 2011	Ral 7016
058000733	058000738

2.275,00 €
1.219,00 €

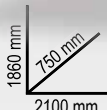

C56PL 0

056000021 18,5 kg

~~415,00 €~~
239,00 €

Folding workbench lightweight reliable

- Lightweight, easy to carry.
- Worktop (800x500mm) made of galvanized sheet iron, for use on one side, protected by an anti-oil and anti-petrol rubber cover.
- Handle with rubber cover, for easy transportation.
- An additional sturdy, reliable worktop, always within reach

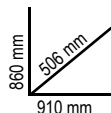

**EVEN LIGHTER!
ONLY 18.5 KG**

C56BLP

056000005 11,4 kg

~~369,00 €~~
189,00 €

NEW!

Multi-purpose folding workbench

- Worktop (820x630 mm) made from polypropylene, with graduation in millimetres and inches
- Handle for easy transportation
- Lower shelf for objects
- Telescopic aluminium legs (550-820 mm)
- Can be used as a stand
- Non-slip feet



ONLY 11,4 KG!



**READY FOR USE IN JUST A FEW SECONDS,
EASY TO CARRY AND STORE IN SMALL SPACES.**

FIXED ACCESSORIES INCLUDED:

- SLIDING CLAMPS (2 PCS)
- FIXED CLAMPS (2 PCS)
- SHEET METAL SUPPORT (2 PCS)

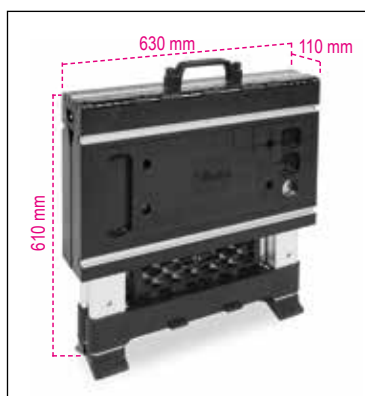

3068
 030680000 61 kg
 924,00 €
429,00 €



3069
 030690000 69,5 kg
 869,00 €
389,00 €

Manual pallet truck with low forks

Features:

- 2 steering wheels, 200x50 mm, made of F
- Double front rollers, 80x70 mm, made of F
- Pallet access entry and exit rollers
- Depth stop notch
- Lowering speed control valve
- Safety overload valve

Technical data:

- Maximum capacity: 2500 kg
- Overall length: 1200 mm
- Fork length: 800 mm
- Fork width: 540 mm
- Individual fork width: 160 mm
- Lever height: 1230 mm
- Max. lifting height: 115 mm



Manual pallet truck

Features:

- 2 steering wheels, 200x50 mm, made of PU
- Double front rollers, 80x70 mm, made of PU
- Pallet access entry and exit rollers
- Depth stop notch
- Lowering speed control valve
- Safety overload valve
- **3-position operating lever**

Technical data:

- Maximum capacity: 2500 kg
- Overall length: 1550 mm
- Fork length: 1150 mm
- Fork width: 540 mm
- Individual fork width: 160 mm
- Lever height: 1230 mm
- Max. lifting height: 115 mm
- Pallet storage corridor:
800x1200 lengthwise: 1805 mm
- Turning radius: 1347 mm



C48M
 048000230 140 kg
 3.290,00 €
1.850,00 €



Electric platform cart, with panels

- Motorized platform, with 24V - 400W motor with 2x12V 33Ah battery supply and Curtis control card
- Loading floor made from sturdy steel, coated with non-slip rubber, with round tubular panels preventing objects from falling during transport
- The panels can be removed, to cater to individual transportation requirements
- Fitted with 2 pneumatic traction wheels (Ø 260 mm) and 2 swivelling rubber wheels (Ø 150mm), electromagnet brake and differential gear
- Supplied with an external battery charger, 220V/50Hz - V/A 24/12



FUNCTIONAL SPECIFICATIONS

- Carrying capacity: 400 kg
- Driving speed: 4-6 km/h (adjustable)
- Battery life: 4 hours
- Maximum permitted slope with a full load: 6%
- Maximum permitted slope with 100 kg load: 18%

TECHNICAL SPECIFICATIONS

- Overall dimensions: 1280x630x1100h mm
- Useful dimensions of loading platform with panels: 1180x580 mm
- Useful dimensions of loading platform without panels: 1260x620 mm
- Height of loading platform from floor: 320 mm
- Height of battery compartment from floor: 65 mm
- Weight with batteries: 140 kg

SAFETY DEVICES:

- Electronic brake
- Buzzer
- Anti-crushing guard
- Battery charge indicator
- Curtis control cart

C41H

21 kg

Two-module tool trolley

- Sheet metal frame and plastic tops, synonymous with remarkable sturdiness and reduced weight
- 2 detachable modules:
 - 1 upper tool box,
 - 1 module with 2 drawers 95 mm in height, 1 pull-out case made of plastic, 66 mm high, and 1 drawer 295 mm in height
- Oversized castors (160 mm), built into frame for easy transport - for example, on steps
- Side centralized lock for closing drawers of lower module
- Drawers with ball bearing slides and double closing hook
- Telescopic aluminium handle
- Small tool holder built into upper tool box
- Lower drawer with double ballbearing slide

- 041000002 041000021
- 041000024 041000006
- 041000012 041000008
- 041000010 041000005

~~684,00 €~~
375,00 €



C41H W
RAL 9016

C41H Y
RAL 1023

C41H R
RAL 3000

C41H V
RAL 6016

C41H B
RAL 5002

C41H G
RAL 7016

C41H N
RAL 9005

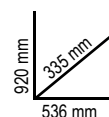

C19

021190001 3,4 kg

~~66,00 €~~
38,00 €

Three-section cantilever tool box, made from sheet metal, empty

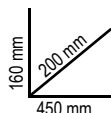

C20L

021200002 5,4 kg

~~102,00 €~~
58,00 €

Five-section cantilever tool box, made from sheet metal, empty

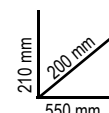

CP15

021150201 2 kg

~~56,50 €~~
32,00 €

Tool box, made from plastic, removable tote-tray and tool trays, empty

- 1 tool tray built into cover
- 2 removable tool trays with adjustable partitions
- 1 interior tote-tray with adjustable partitions
- Carrying capacity: 30 kg



Tool trunk, made of sheet metal, empty

C22B-0

022000150 13 kg

~~264,00 €~~
151,00 €

720x320x310 mm

C22BM-0

022000160 20 kg

~~304,00 €~~
175,00 €

850x360x350 mm

C22BL-0

022000170 26 kg

~~405,00 €~~
234,00 €

1010x410x400 mm



2700S/VU

NEW!

20 kg

Folding tool trolley for outdoor jobs, with 100 tools



995 mm

PATENTED!

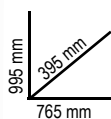

~~1,270,00 €~~
499,00 €

- Sheet metal frame.
- Registered model. 2 drawers, 588x277 mm, with ball bearing slides, for two-way opening.
- Large lower storage compartment, 588x277x220 mm.
- 2 fixed castors, Ø 160 mm, and 2 steering castors with brake, Ø 100 mm
- Thermoplastic worktop with 6 built-in tote trays.
- Centralized lock.
- Can accommodate drawer partitions and MC foam tool trolleys.



Ral 2011	Ral 7016	Ral 3000
027000231	027000232	027000233

n°		
2	70 mm	20 kg

- Folding tool trolley; pillars can swing down for space saving transport.

+100 TOOLS **Included in the price**

net value

€ 220



Quantity/Description	Beta N.
7 combination wrenches 6-7-8-10-13-17-19 mm	42
9 offset hexagon key wrenches Ø 1,5-2-2,5-3-4-5-6-8-10 mm	BW 96N/SC9
1 Adjustable wrench 150 mm	111E
61 Set of 60 bits with magnetic bit holder, in pocket-size case	BW 861/C61
1 diagonal cutting nippers, slip-proof double layer PVC coated handles, industrial finish ∇ 160 mm	1082G
1 electrician's scissors, straight blades	1128BMX
1 heavy duty combination pliers, slip-proof double layer PVC coated handles, industrial finish ∇ 180 mm	1150G
3 screwdrivers for slotted head screws \bullet 3,5x100-5,5x150-6,5x150	1290
3 screwdrivers for cross head Phillips® screws \oplus PH0x100-PH1x120-PH2x150	1292
1 engineer's hammer 300g	1370
1 measuring tape 3m	1692
1 snap - off blade utility knife 18 mm	1771
10 18 mm snap-off spare blades (10 pieces) for utility knives 1771, 1771BM, 1771HD 1771RL	



C51

21 kg

Trolley

- 3 tops covered in antislip ribbed rubber
- Two fixing options for central worktop
- Four castors Ø 100 mm:
2 fixed and 2 steering (1 with brake)



Ral 2011	Ral 7016	Ral 3000
051000001	051000002	051000003

~~344,00 €~~
193,00 €

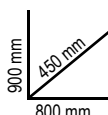

2080/V12
 020800000 1,8 kg
~~70,00 €~~
40,00 €

Organizer tool case with 12 removable tote-trays

Removable, folding clear tote-trays, for immediate recognition of contents



300x330x145 mm

2080/V17
 020800200 750 g
~~26,50 €~~
15,00 €

Organizer tool case with 17 removable tote trays

A must-have for accommodating and carrying smallwares tidily and accurately.



335x285x65 mm



2080/DS
 020800210 760 g
~~24,20 €~~
14,00 €

SMALL organizer tool case, with 15 compartments and 10 removable partitions

The perfect solution for carrying smallwares, including screws, nuts, washers, rivets and dowels.



Can be put on top, and hooked to, each other



375x315x65 mm



2080/DL
 020800211 970 g
~~28,50 €~~
16,50 €

LARGE organizer tool case, with 15 compartments and 8 removable partitions



440x330x75 mm



Can be put on top, and hooked to, each other

2036/TV
 020360000 7,5 kg
~~615,00 €~~
329,00 €

Tool trolley, made of thick polypropylene, aluminium edged

- 2 tool panels
- Telescopic handle
- Ball bearing castors



480x267x408 mm



- 2 tool panels

C5
 021050000 2,8 kg
~~180,50 €~~
103,00 €

Rucksack, empty

- Removable interior tool panel
- Six exterior pockets and two interior pockets
- Waterproof plastic base
- Double safety lace for fixing rucksack to shoulders
- Ergonomic padded back



400x200x500 mm

C6T
 021060010 4,9 kg
~~256,00 €~~
150,00 €

Rucksack with castors, empty

- Telescopic handle for easy transport
- Built-in castors with practical dustproof cover for use as a rucksack
- Two removable tool panels
- Interior PC pocket and five exterior pockets
- Waterproof plastic base



360x200x480 mm

Technical fabric tool box, empty

- Hard frame
- Double bottom
- Tilting handle for easier access to tools
- Elastic tool bands and interior and exterior pockets
- Cover
- Tool tray included in double bottom
- Can be used with trolley C8

C10S
 021100001 2,9 kg
~~144,00 €~~
84,00 €

C10
 021100000 3,3 kg
~~183,00 €~~
109,00 €



(C10S - 420 mm) (C10 - 520 mm)

C11
 021110000 1,8 kg
~~106,50 €~~
63,00 €

Technical fabric tool box, empty

- Hard water resistant plastic base
- Elastic tool bands and interior and exterior tool pockets
- Document holders built into double bottom of cover



410x230x250 mm

C7AT
 021070010 2,8 kg
~~143,00 €~~
81,00 €

Servicing tool bag made from technical fabric, empty

- Made from super durable technical fabric
- Reinforced base with rubber feet
- Dual top handle for a safe, balanced hold
- Large front document pocket with zip closure and additional compartment with dual strap + clip closure
- dual side pocket with strap closure
- Capacious interior compartment with additional document pocket
- Supplied complete with adjustable padded shoulder strap



470x200x340 mm



- **Front zipper opening on both bag sides for quick access to tools:**
- 29 compartments and 13 elastic tool bands on front side
- 33 tool compartments on rear side

- PC and tablet compartment with protective interior padding (PC size up to L=370 mm, H=250 mm)

C9DA

021090005 2,4 kg

115,50 €
67,00 €

Tool bag with large opening, empty

- Made from super durable technical fabric
- Hard plastic base, water-resistant
- Reinforced top handle for a safe hold
- Dual side pocket with strap closure
- Supplied complete with adjustable padded shoulder strap
- **Two side tool compartments with large openings**, for quick access to and perfect visibility of contents
 - 22 tool pockets and additional compartment with zip closure on front side
 - 14 tool pockets and additional zipped compartment on rear side



420x220x310 mm

C3

021030000 917 g

75,00 €
43,00 €

Mini tool bag, made from technical fabric

- 1 exterior front pocket with zip closure
- 2 side pockets with tote trays
- 1 convenient rear pocket with Velcro closure
- 1 removable interior tool panel, with elastic bands on both sides
- Complete with shoulder strap



230x110x320 mm



• USB interface for charging mobile devices



2001/BZ27 VU

020010157 3,9 kg

322,00 €
186,00 €

Folding tool case with assortment of 27 tools, for universal use



380x290x60 mm



27

Quantity/Description	Beta N.
1 electrician's scissors, straight blades	1128BMX
1 combination pliers bright chrome-plated 180 mm	1150
6 combination wrenches 7-8-10-13-17-19 mm	42
3 screwdriver for slotted head screws 3x75-4x100-5,5x150 mm	1201E
3 screwdriver for cross head Phillips® screws PH0x60 - PH1x80 - PH2x100 mm	1202E
9 offset hexagon key wrenches 1,5-2-2,5-3-4-5-6-8-10 mm	96/SC9
1 engineer's hammer 300 g	1370
1 Slip joint pliers boxed joints 250 mm	1048N
1 measuring tape 5 m	1692/5
1 snap - off blade utility knife 18 mm	1771

42

BETA'S ICONIC WRENCH



A stylish, slim shape enhanced by a slender profile, lighter to the touch.

The strength, resilience and ergonomic design of the Beta wrench reach even higher values, to provide users with the best possible tool. The manufacturing process is carried out in our factories in Sovico and Sulmona, on the basis of state-of-the-art automation technology and the best trained workers.



POWERFUL

Torque values more than doubled compared to the requirements to be satisfied under ISO 1711.

STRENGTH

Remarkable strength: in case of improper use, the wrench buckles, without breaking suddenly and dangerously.

ERGONOMIC

The offset ring has a 15 degree angle to protect the hand. The shape is obtained from a die; it is not bent later.

42/SP15
000421078 ~~217,00 €~~
120,00 €

Set of 15 combination wrenches with holder



6-7-8-9-10-11-12-13-14-15-16-17-19-22-24 mm

42/SP25
000421085 ~~536,00 €~~
307,00 €

Set of 25 combination wrenches with holder



6-7-8-9-10-11-12-13-14-15-16-17-18-19-20-21-22-23-24-25-26-27-28-30-32 mm

55/B12N
000550164 ~~168,00 €~~
98,00 €

Set of 12 double open end wrenches in roll-up wallet made of durable polyester



6x7-8x9-10x11-12x13-14x15-16x17-18x19-20x22-21x23-24x26-25x28-30x32 mm

42/SC9I
000421087 ~~122,00 €~~
70,00 €

Set of 9 combination wrenches with compact support

- Compact, practical, easy-to-carry support
- Quickly identified wrench size
- Wrench safely locked in support



8-10-11-12-13-14-15-17-19 mm

141/B6

001410066

Set of 6 ratcheting combination wrenches, straight series, in cloth wallet

8-10-13-14-17-19 mm



~~149,00 €~~
76,00 €

142SN/SC9

001420259

Set of 9 swivel end ratcheting combination wrenches, with compact support

8-10-11-12-13-14-15-17-19 mm



142/SC9I

001420087

Set of 9 reversible ratcheting combination wrenches, with compact support

8-10-11-12-13-14-15-17-19 mm



~~293,00 €~~
168,00 €

~~244,00 €~~
140,00 €

192/S2

001920070

Set of 2 reversible ratcheting offset bi-hex ring wrenches



8 SIZES IN 2 WRENCHES

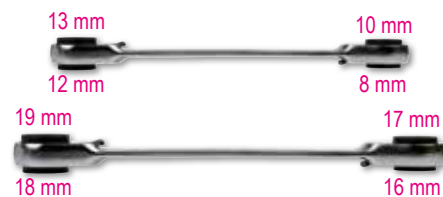

~~74,00 €~~
43,00 €

186 8-32

001860008

Self-locking wrench with automatic take-up device for hexagons, 8 to 32 mm
Ideal for hexagon, Spline, square and Torx® head screws, including damaged screws



L 260 mm

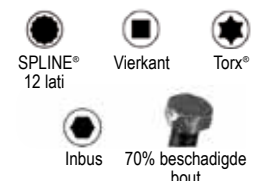

~~55,50 €~~
32,00 €

111

THE ADJUSTABLE WRENCHES WITH SCALES



Beta 111E allow differently sized nuts and bolts to be tightened and loosened through the sliding jaws, which can be adjusted through the central rolls.

Head angled at 15°, allowing hardly accessible spaces to be reached, as is the case with our iconic combination wrenches, "42"

15°

Made from high-performance alloy steel for increased mechanical torsional strength

Hole on handle for hanging wrench

Double laser marking in mm/inches

Compact head with completely open jaw

Special heat treatment for excellent wear resistance

Based on the new ergonomic properties, weight has been **reduced by 20%**

111E



Adjustable wrenches with scales, **chrome-plated**

- right-hand rotation of pin

A max



	L mm	L "	A max mm		€
111E 100	100	4	15	001110110	28,50 € 17,00 €
111E 150	150	6	24	001110115	29,50 € 17,00 €
111E 200	200	8	29	001110120	36,50 € 21,00 €
111E 250	250	10	34	001110125	44,80 € 26,00 €
111E 300	300	12	40	001110130	58,50 € 34,00 €
111E 380	380	15	45	001110138	114,50 € 67,00 €
111E 450	450	18	54	001110145	198,50 € 111,00 €
111E 600	600	24	62	001110160	263,00 € 153,00 €

111E/D3

001110163

~~110,00 €~~
58,00 €

NEW!

Set of 3 adjustable wrenches with scales, **chrome-plated**

111E 150

111E 200

111E 250



111CM



Wide opening adjustable wrenches, **chrome-plated**, short series

- right-hand rotation of pin

A max



	L mm	L "	A max mm		€
111CM 170	170	6	32	001110770	43,50 € 25,00 €
111CM 220	220	8	38	001110722	53,00 € 31,00 €
111CM 270	270	10	46	001110727	70,00 € 41,00 €

111EN



Adjustable wrenches with scales, **phosphated**

- left-hand rotation of pin

A max



	L mm	L "	A max mm		€
111EN 100	100	4	15	001110410	26,00 € 15,00 €
111EN 150	150	6	24	001110415	27,50 € 16,00 €
111EN 200	200	8	29	001110420	32,00 € 18,00 €
111EN 250	250	10	34	001110425	39,50 € 23,00 €
111EN 300	300	12	40	001110430	53,50 € 31,00 €
111EN 380	380	15	45	001110438	105,50 € 62,00 €
111EN 450	450	18	54	001110445	188,00 € 105,00 €

96/SC9
 000960374 ~~23,90 €~~
13,00 €

Set of 9 offset hexagon key wrenches

Ø mm	L mm
1,5	45
2	50
2,5	57
3	64
4	72
5	83
6	94
8	105
10	119



96BPC/SC9
 000960354 ~~50,00 €~~
25,00 €

Set of 9 ball head offset hexagon key wrenches

Ø mm	L mm
1,5	79
2	84
2,5	89
3	99
4	108
5	126
6	148
8	168
10	187



97BTX/SC8
 000970164 ~~89,50 €~~
48,00 €

Set of 8 ball head offset key wrenches, long model, for Torx® head screws

Ø mm	L mm
T9	62
T10	71
T15	81
T20	92
T25	94
T27	105
T30	114
T40	129



97BTXL/SC8
 000970364 ~~103,50 €~~
54,00 €

Set of 8 ball head offset key wrenches, long model, for Torx® head screws

Ø mm	L mm
T9	80
T10	86
T15	100
T20	110
T25	126
T27	140
T30	160
T40	176

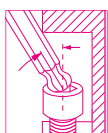

EXTRA LONG VERSION +25%



97BRTL/SC8
 000970464 ~~104,50 €~~
50,00 €

Set of 8 ball head offset key wrenches, long model, for Tamper Resistant Torx® head screws

Ø mm	L mm
T9	80
T10	86
T15	100
T20	110
T25	126
T27	140
T30	160
T40	176

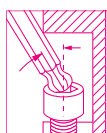

EXTRA LONG VERSION +25%



96LP/SC9
 000961354 ~~58,50 €~~
32,00 €

Set of 9 ball head offset hexagon key wrenches

Ø mm	L mm
1,5	90
2	100
2,5	112
3	127
4	144
5	163
6	184
8	204
10	230

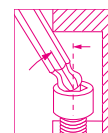

EXTRA LONG VERSION +30%



96BP-HO/SC9
 000961254 ~~54,00 €~~
26,00 € **NEW!**

Set of 9 ball head offset hexagon key wrenches, with screw holding system

Ø mm	L mm
1,5	79
2	84
2,5	89
3	99
4	100
5	126
6	148
8	168
10	187



953/S5
 009530305 ~~194,50 €~~
109,00 €

Set of 5 T-handle wrenches with swivelling hexagon male ends

Ø 3-4-5-6-8 mm

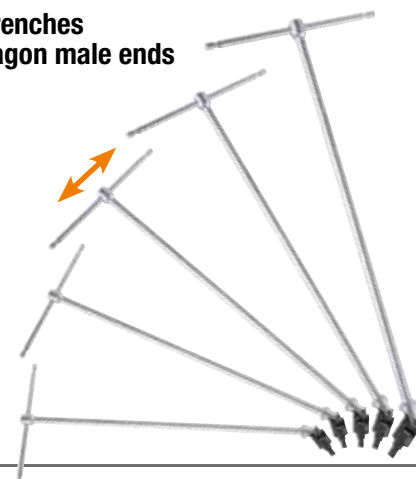
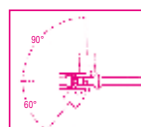

96T/S5P
000960946

~~72,00 €~~
41,00 €



Set of 5 offset hexagon key wrenches with handles

○ 2,5-3-4-5-6 mm



97TTX/S6
000970791

~~102,50 €~~
54,00 €



Set of 6 ball head offset key wrenches for Torx® head screws with handles

○ T10-T15-T20
T25-T30-T40



951 **951/S6**
009510687

~~145,50 €~~
82,00 €



THE ORIGINAL ONE

When this wrench was launched, back in 1980, it was a revolution. Designed to work on high-resistance screws, it is the name for quick handling, accurate fit and flexible use. The hexagon T handle can be adjusted as required. The hexagon ends are designed to transmit the maximum possible torque to the screw. The rod length allows remarkable torques to be effortlessly applied to the screws. Ongoing production improvements have translated, for example, into sandblasted finishes and sharp-edged hexagon ends which allow a better fit onto any screws, including damaged ones. Laser marking results in a sturdier rod.

Set of 6 T-handle wrenches with three hexagon male ends

○ 2,5-3-4-5-6-8 mm



952 **952/D7**
009520079

~~282,00 €~~
164,00 €



THE RELIABLE ONE

Reliable, precise pre-positioning is the secret for the success of this wrench. The articulated joint maintains its function over the years, no adjustment being required. Socket rotation angle: 50°. Can be used at 90° in fixed position. Sliding T-handle, can be stopped in the required position throughout its length. Triple size marking on head.

Set of 7 T-handle wrenches with swivelling hexagon sockets

○ 7-8-10-12-13-14-17 mm

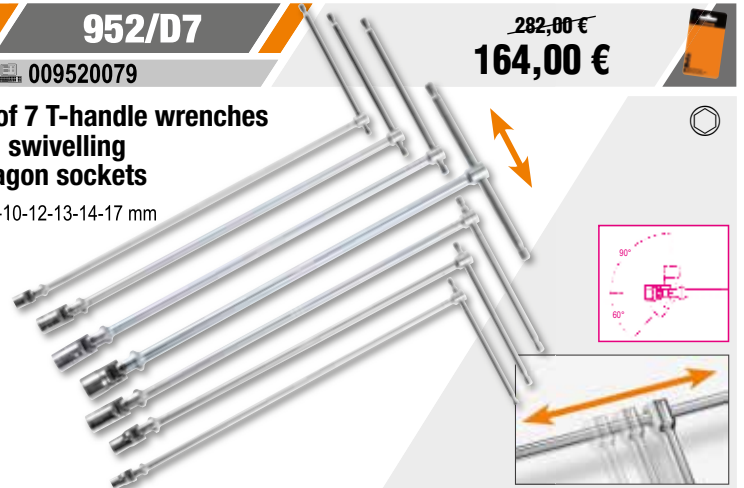

950/D6
009500096

~~193,00 €~~
109,00 €



Set of 6 T-handle hexagon socket wrenches

○ 7-8-10-13-17-19 mm



96BP-CL/SC9
 000961619 ~~61,00 €~~
33,00 €

Set of 9 ball head offset key wrenches, coloured, with compact support

Ø mm	L mm
1,5	91
2	102
2,5	113
3	128
4	143
5	163
6	185
8	206
10	231

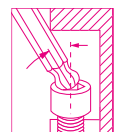

97BTX-C/SC8
 000971658 ~~99,00 €~~
54,00 €

Set of 8 coloured ball head offset key wrenches, for Torx® head screws, with compact support

Ø mm	L mm
T9	80
T10	86
T15	90
T20	95
T25	100
T27	105
T30	114
T40	124



142MC/SC9I
 001422087 ~~255,00 €~~
146,00 €

Set of 9 reversible ratcheting combination wrenches, coloured, with compact support

Ø mm	L mm
8x8	136
10x10	159
11x11	168
12x12	174
13x13	180
14x14	190
15x15	200
17x17	233
19x19	248



EXTRA LONG VERSION +30%

860/C27
 008600880 ~~103,00 €~~
58,00 €

Set of 25 bits, 1 connector and 1 reversible ratchet in plastic case

- 860LP 0,5x3-1,0x5,5-1,2x6,5 mm
- 860PE 2-2,5-3-4-5-6 mm
- ⊕ 860PH PH1-PH2(x2)-PH3
- ⊕ 860TX T6-T8-T10-T15-T20-T25-T30-T40
- ⊕ 860PZ PZ1-PZ2(2x)-PZ3
- 860/55 100 mm
- 892/0 ○ 1/4 ■ 1/4



860/C38P
 008600878 ~~223,00 €~~
109,00 €

Set of 1 reversible ratchet bit holder with articulated handle, 27 bits, 8 hexagon sockets and 2 accessories

- 860LP 0,6x4,5-0,8x5,5-1,0x5,5-1,2x6,5 mm
- 860PE 2-2,5-3-4(x2)-5(x2)mm
- ⊕ 860PH PH1(x2)-PH2(x2)-PH3
- ⊕ 860TX T10-T15-T20-T25-T30-T40
- ⊕ 860PZ PZ1(x2)-PZ2(x2)-PZ3
- 900 ○ 5-5,5-6-7-8-9-10-13 mm
- 892/0 ● 1/4 ■ 1/4
- 892/3 ● 1/4 ■ 1/4
- 855P Ⓢ 240 mm



1263MC/D8
 012632008 ~~73,50 €~~
42,00 €

Set of 8 coloured screwdrivers

- 1260MC ● 2,5x50-3x75-4x100- 5,5x125 6,5x150 mm
- 1262MC ⊕ PH0x60-PH1x80 PH2x100 mm



1257LPH/S8
 012570210 ~~77,00 €~~
44,00 €

Set of 8 micro-screwdrivers for slotted head screws and Phillips® screws in hard case

- 1257PH ⊕ PH00-PH0-PH1
- 1257LP ● 0,4x2-0,4x2,5-0,5x3 0,6x3,5-0,8x4 mm



180x120x50 mm

THE FUNCTIONAL, ERGONOMIC BETA EVOX SCREWDRIVER

Beta **evox-E** IS ALSO ELECTRICAL NOW!

Life: you can tighten up in up to 1,000 screws with one charging cycle

1/4

Versatility: this item caters to all needs; it is supplied with a belt case, complete with 6 50-mm bits with mixed heads. In addition, it can be used with all bits with 1/4" hexagon drives.

Convenience: the reduced dimensions and front LEDs make it perfect for use in small, poorly lit spaces.

Flawless grip: it fits your hand and allows a firm, comfortable hold, during both electrical and manual operation, resulting in reduced hand and wrist fatigue.

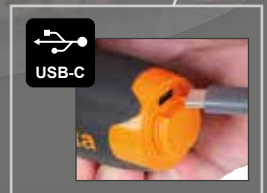

6 50mm-LONG MIXED BITS INCLUDED

1210E/GE

0121100701

Evox-E electric screwdriver

~~193,50 €~~
109,00 €



1211E/GE

0121110701

Evox-E electric screwdriver

~~206,50 €~~
119,00 €



Technical data:

- 3.7V 2300mAh lithium battery
- Maximum torque in electric mode: 1.2 Nm
- **Over 1,000 screw fastenings at 1.2 Nm per charging cycle**
- **Speed: 250 rpm**
- **Outstanding static resistance (up to 12 Nm, manual tightening)**
- Outstanding mechanical resistance
- 1/4" magnetic bit holder
- Compatible with all standardized bits
- Rechargeable via USB-C cable (included)
- USB-C port protected with screw cap
- Front ring LEDs for improved visibility of working area
- When charging, steady LEDs indicate that charging is complete
- Ergonomic nylon handle inspired by Evox screwdriver
- Built-in and sealed operation buttons
- Convenient belt pouch with bit pockets (6 mixed bits included)

1203E/D5

012031001

~~35,00 €~~

20,00 €



Set of 5 screwdrivers

1201E ● 3,5x100-5,5x150-6,5x150 mm
1202E ● PH1x80-PH2x100 mm

1203E/D8P

012031018

~~49,00 €~~

28,00 €



Set of 8 screwdrivers

1201E ● 2,5x50-3x75-4x100-5,5x100-6,5x150 mm
1202E ● PH0x60-PH1x80-PH2x100 mm

1203E/D10N

012031019

~~62,50 €~~

36,00 €



Set of 10 screwdrivers

1201E ● 2,5x50-3x75-4x100-5,5x150-6,5x150 mm
1202E ● PH0x60-PH1x80-PH2x100 mm
1201EN ● 4x30 mm
1202EN ● PH1x30 mm

1207E/TX-D7

012071207

~~63,50 €~~

36,00 €



Set of 7 screwdrivers

1207E/TX ● T6-T8-T10-T15-T20-T25-T30

1263/D8

012630008

~~69,00 €~~

39,00 €



Set of 8 screwdrivers

1260 ● 2,5x50-3x75-4x100- 5,5x125-6,5x150 mm
1262 ● PH0x60-PH1x80-PH2x100 mm

1263/D10

012630010

~~87,50 €~~

50,00 €



Set of 10 screwdrivers

1260 ● 3x75-3,5x100-4x125-5,5x150-6,5x150 mm
1262 ● PH0x60- PH1x80-PH2x100 mm
1260N ● 4x30 mm
1262N ● PH1x30 mm

1267TX/D7

012670307

~~86,50 €~~

49,00 €



Set of 7 screwdrivers

1267TX ● T6-T8-T10-T15-T20-T25-T30

1293/S12

012930203

~~149,50 €~~
54,00 €



Set of 12 screwdrivers

1290 ● 0,5x3x75-0,8x4x125-1x5,5x150
1,2x6,5x150-1,2x8x200 mm
1290N ● 0,8x4x30 mm
1292 ● PH0x3x60 -PH1x4,5x80
PH2x6x100-PH3x8x150 mm
1292N ● PH1x4,5x30-PH2x6x30 mm



1243/D7

012430017

~~116,50 €~~
67,00 €



Set of 7 screwdrivers with steel heads

1241 ● 5,5x100-6,5x125-1,2x150-1,6x200 mm
1242 ● PH1x100-PH2x100-PH3x150 mm



Beta *evolution*
THE EVOLUTION OF THE SCREWDRIVER!

Set of 10 bits with magnetic bit holder, in pocket case

1/4

NEW!

861MIX/A10

008610800

~~34,50 €~~
11,00 €



- 861LP 0,5x3-1x5,5-1,2x6,5 mm
- ⊕ 861PH PH1-PH2(x2)-PH3
- ⊕ 861PZ PZ1-PZ2-PZ3
- 882M1 ○ 1/4 ● 1/4

861PE/A10

008610820

~~36,50 €~~
11,00 €



- 861PE 2-2,5-3(x2) 4(x2)-5(x2) 6-8 mm
- 882M1 ○ 1/4 ● 1/4

861PHZ/A10

008610810

~~34,50 €~~
11,00 €



- ⊕ 861PH PH1-PH2(x3)-PH3
- ⊕ 861PZ PZ1-PZ2(x3)-PZ3
- 882M1 ○ 1/4 ● 1/4

861TX/A10

008610870

~~37,50 €~~
11,00 €



- ⊕ 861TX T7-T8-T9-T10 T15-T20-T25 T27-T30-T40
- 882M1 ○ 1/4 ● 1/4

867/C52

008670901 2,1 kg

~~157,50 €~~
87,00 €

Set of 52 hexagon bits, 10 mm and 2 accessories

10mm

52x



250x170x70 mm

867PE	○	4-5-6-7-8-10-12 mm
867PE/L	○	4-5-6-7-8-10-12 mm
867XZN	○	M5-M6-M8-M10-M12
867XZN/L	○	M5-M6-M8-M10-M12
867TX	⊕	T20-T25-T30-T40-T45-T50-T55
867TX/L	⊕	T20-T25-T30-T40-T45-T50-T55
867RTX	⊕	T20-T25-T30-T40-T45-T50-T55
867RTX/L	⊕	T20-T25-T30-T40-T45-T50-T55
867/1	○	10 mm - □ 3/8"
867/2	○	10 mm - □ 1/2"

862F/A7

008620950

~~58,50 €~~
34,00 €

Set of 7 magnetic bits, hexagon sockets, in plastic case

○ 5,5-6-7-8-10-12-13 mm

7x



862XP/A16

008620960

~~78,00 €~~
41,00 €

Set of 16 impact bits in pocket-size case

- Bits
- ⊕ PH2(x2)-PH3
 - ⊕ PZ2(x2)-PZ3
 - T20-T25(x2) T30(x2)-T40(x2)
 - 4-5-6 mm

16x



50 mm

1256/C36-2

012560100 200 g

~~80,00 €~~
47,00 €

Bi-material microscrewdriver with 36 interchangeable 4-mm bits and magnetic extension

1256TX	⊕	T3-T4-T5-T6-T7-T8-T9-T10-T15
1256RTX	⊕	T6-T7-T8-T9-T10
1256LP	●	0,8-1,2-1,5-1,8-2-2,5-3-3,5-4 mm
1256PE	○	0,7-0,9-1,3-1,5-2 mm
1256PH	⊕	PH000-PH00-PH0-PH1
1256PZ	⊕	PZ000-PZ00-PZ0-PZ1
1256/20		
1256/30		



130x60x35 mm

1600Q 10 43,50 €
25,00 €
016000010

- 1/4" Eight-way wrench, with articulated joint, for control panel operators**
- Eight-way wrench, can be rotated to easily select the head to use.
 - Magnetic articulated joint for increased force.
 - 1/4" male drive for use of sockets.



Wrench for maintenance in numerous sectors, including electrical industry, plumbing, ventilation and gas.



861/C100 109,00 €
50,00 €
008616998

- 1/4" Set of 98 bits with 2 bit holders, in case**
- For manual, electric and pneumatic screwdrivers

155x117x37 mm



100x

- 861LP 3-4-4,5-5,5(x3)-6,5(x2)-8(x2) mm
 - ⊕ 861PH PH0(x2)-PH1(x3)-PH2(x3)-PH3(x2)-PH4
 - ⊕ 861PZ PZ1(x3)-PZ2(x3)-PZ3(x2)-PZ4
 - 861PE 2-2,5(x2)-3(x2)-4(x2)-5(x2)-6(x2)-8-10 mm
 - ⊗ 861TX T6-T7-T8-T9-T10(x2)-T15-T20(x2)-T25(x2)-T27-T30(x2)-T40(x2)
 - ⊗ 861RTX T6-T7-T8-T10-T15-T20-T25-T27-T30-T40
 - ⊗ 861XZN M5-M6-M8
 - ⊕ 861TQS 0-1-2-3-4-5-6-8-10
 - ⊕ 861TRW 1-2-3-4-5-6
 - ⊕ 861SP 4-6-8-10-12
 - 861SQ 0-1(x2)-2(x2)-3
- Icons: : - (x2)

900/C39N 232,50 €
131,00 €
009000947

- 1/4" Assortment of 11 hexagon sockets, 21 bits and 7 accessories, in plastic case**



39x

150x97x53 mm

	900		5-5,5-6-7-8-9-10-11-12-13-14 mm	11
	900/20		50 mm	1
	900/20L		100 mm	1
	900/25			1
	900BG/30C		128 mm	1
	892/0		■ 1/4 - ● 1/4	1
	895/1		○ 1/4 - □ 1/4	1
	861LP		0,6x4,5-1,2x6,5-1,2x8 mm	3
	861PH		PH1-PH2-PH3	3
	861PZ		PZ1-PZ2-PZ3	3
	861PE		2,5-3-4-5-6 mm	5
	861RTX		T10-T15-T20-T25-T27-T30-T40	7
	900/55Z		126 mm	1



900/C39U 235,00 €
131,00 €
009001947

- 1/4" Assortment of 11 gear lock sockets, 21 bits and 7 accessories, in plastic case**



39x

150x97x53 mm



	900U	mm	5-5,5-6-7-8-9-10-11-12-13-14 mm	11
		"	13/64-7/32-1/4-9/32-5/16-11/32-3/8-7/16-15/32-1/2-9/16	
		XZN	M6-M8-M10-M12-M14-M16-M18	
		FTX	E7-E8-E10-E12-E14-E16-E18	
	900/20		50 mm	1
	900/20L		100 mm	1
	900/25			1
	900BG/30C		128 mm	1
	892/0		■ 1/4 - ● 1/4	1
	895/1		○ 1/4 - □ 1/4	1
	861LP		0,6x4,5-1,2x6,5-1,2x8 mm	3
	861PH		PH1-PH2-PH3	3
	861PZ		PZ1-PZ2-PZ3	3
	861PE		2,5-3-4-5-6 mm	5
	861RTX		T10-T15-T20-T25-T27-T30-T40	7
	900/55Z		126 mm	1

BETA'S RANGE OF RATCHETS

NEW!

NEW DESIGN



Ratchet with up to **72 teeth**:
take-up angle of 5° for jobs in small areas

Phosphated square drive

Minimum head size

INNOVATIVE MATERIALS FOR TOP PERFORMANCE

Ergonomic bi-material handle

Hanging hole on handle



- Designed and manufactured in the company's Italian-based factories, has been restyled.
- Hand pressing on head does not cause any reversal and allows for free lever return
- One-handed reversal

The versions with 1/2" and 3/4" square drives allow for reduced weight, thus resulting in a product synonymous with optimal handiness, superior ease of use as well as uncompromising sturdiness and performance.



	L mm	Ø mm	A mm	■	Denti	📄	€
900/55	127	25	29	1/4"	72	009001155	53,00 € 30,00 €
910/55	207	31	33	3/8"	72	009101155	57,00 € 32,00 €
920/55	271	40	41	1/2"	72	009201155	69,50 € 39,00 €
928/55	504	58	59	3/4"	72	009281155	182,50 € 105,00 €

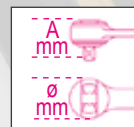

900/C11

009000971 1,2 kg

~~254,00 €~~
146,00 €

11 hexagon sockets,
20 bits and 8 accessories, in metal case

	861LP	●	0,5x3-0,8x5,5-1x5,5-1,2x6,5 mm
	861PE	○	3-4-5-6-8 mm
	861PH	⊕	PH0-PH1-PH2-PH3
	861TX	⊗	T8-T10-T15-T20-T25-T30-T40
	895/1	○	1/4" - 1/4"
	900	○	5-5,5-6-7-8-9-10-11-12-13-14 mm
	900/16	□	1/4" - 3/8"
	900/20		50 mm
	900/21		150 mm
	900/25		
	900/42		
	900BG/30		
	900/55	⊗	

1/4"

1/4"



39x

270x120x45 mm

902A/C22

009020807 3,5 kg

~~408,00 €~~
232,00 €

Assortment of 22 hexagon sockets and 6 accessories, in metal case

1 1/4"		900	5-5,5-6-7-8-9-10-11-12-13 mm
		900/20	50 mm
		900/25	
		900/55	
1 1/2"		920A	10-13-14-15-17-18-19-22-24-27-30-32 mm
		920/21	125 mm
		920/25	
		920/55	

420x185x60 mm



910A/C16

009100936 2,4 kg

~~296,00 €~~
169,00 €

Assortment of 16 hexagon sockets and 5 accessories in foam tray, in metal case

	910A	6-7-8-9-10-11-12-13-14-15-16-17-18-19-21-22 mm	3/8"
	910/21	125 mm	
	910/22	250 mm	
	910/25		
	910/42	210 mm	
	910/55		

335x145x60 mm



920A/C17M

009200924 5 kg

~~364,00 €~~
208,00 €

Assortment of 17 hexagon sockets and 5 accessories in foam tray, in metal case

	920A	10-11-12-13-14-15-16-17-18-19-20-21-22-24-27-30-32 mm	1 1/2"
	920/21	125 mm	
	920/22	255 mm	
	920/25		
	920/42	305 mm	
	920/55		

420x185x60 mm



928A/C12

009280955 13 kg

~~962,00 €~~
549,00 €

Assortment of 12 hexagon hand sockets and 5 accessories, in metal case

	928A	22-24-27-30-32-34-36-38-41-46-50-55 mm	3/4"
	928/21	200 mm	
	928/22	380 mm	
	928/25		
	928/42	450 mm	
	928/55		

530x220x80 mm



TORQUE WRENCH ZERO-RESET

THE TORQUE WRENCH THAT DOES NOT REQUIRE RELEASING TENSION



Even if tension is not released, the number of cycles, durability and tightening accuracy as required by reference standards are guaranteed.

In order to confirm these parameters, Beta Utensili's Research & Development Department performed numerous durability tests at the in-house laboratories as at hundreds of end users.

This result has been obtained through:

- the use of the best-performing currently available materials;
- special heat treatments on interior parts.



The Zero-Reset torque wrench was entirely designed and developed in-house and is manufactured at Beta Utensili's factories in Italy, using 100% Italian-made parts.

ZERO-RESET TECHNOLOGY

Based on higher-performance materials and improved heat treatment of both the spring and the component parts of the adjustment system, the wrench no longer requires releasing tension after use.

EASY SETTINGS:

The graduated vernier scale allows minimum interval fractions to be set up (in tenths of Nm).



IMPROVED VISIBILITY:

Double graduation in Nm for clearer, simpler torque visibility.

666

ZERO-RESET click-type torque wrenches with reversible ratchets, for right-hand tightening, torque accuracy: ± 3%

UNI EN ISO 6789

1/4" 3/8" 1/2"



	Nm	■	▤	L (mm)	g	📄	€
666/2	5÷25	1/4"	0,05	273	395	006660702	303,00 € 174,00 €
666/2X	5÷25	3/8"	0,05	273	405	006660703	303,00 € 174,00 €
666/5	10÷50	3/8"	0,25	342	680	006660705	275,00 € 157,00 €
666/10	20÷100	3/8"	0,25	385	760	006660710	277,00 € 158,00 €
666/10X	20÷100	1/2"	0,25	385	770	006660711	283,00 € 162,00 €
666/20	40÷200	1/2"	0,5	471	1020	006660720	301,00 € 171,00 €
666/30	60÷300	1/2"	1	600	1271	006660730	342,00 € 196,00 €

667

ZERO-RESET click-type torque wrenches with push-through ratchets, for right-/left-hand tightening, torque accuracy: ± 3%

UNI EN ISO 6789

1/2" 3/4"



	Nm	■	▤	L (mm)	g	📄	€
667/20	40÷200	1/2"	0,5	471	1035	006670720	296,00 € 168,00 €
667/30	60÷300	1/2"	1	600	1285	006670730	330,00 € 186,00 €
667/40	80÷400	3/4"	1	710	2220	006670740	793,00 € 450,00 €

599DGT-AW

NEW!

Electronic torque wrench, torque and angle readout, with reversible ratchet and wireless data transmission, right-hand (accuracy: $\pm 2\%$) and left-hand (accuracy: $\pm 3\%$) tightening

UNI EN 26789 ISO 6789



1/4" 3/8" 1/2"

- Tightening types: torque, angle, torque + angle
- Dual measurement mode: peak hold and track
- Light indicators, an intermittent sound and tactile feedback inform user that preset torque or angle has been reached
- Last 999 peak torque and/or angle readings can be stored and displayed
- 9 "Preset" modes can be saved and preset
- Key safety lockout
- Wrench can be associated with a certain user via software
- Tightening data traceability. Software allows date and time, tool serial number, set tightening value and reached value to be stored and associated with user ID
- Non-slip bi-material handle
- Wrench + software in 9 languages
- Included: 3 AA - 1.5V batteries, wireless USB key and software USB key



- Bi-directional wireless data transmission, from wrench to software and vice versa, in mass a posteriori or in real time



- Customized data processing software with immediate, easy-to-read OK/NG result and real time display of charts

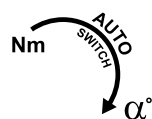

TORQUE + ANGLE

599DGT-AW/30		599DGT-AW/135		599DGT-AW/340	
005990702	1.166,00 € 675,00 €	005990713	1.188,00 € 685,00 €	005990734	1.265,00 € 719,00 €
Nm	Kgfm	lbf.ft	■	L (mm)	
6÷30	0,6÷3	4,5÷22	1/4"	410	0,1
Nm	Kgfm	lbf.ft	■	L (mm)	
27÷135	2,7÷13,5	20÷100	3/8"	445	1,0
Nm	Kgfm	lbf.ft	■	L (mm)	
68÷340	6,8÷34	50÷250	1/2"	615	1,0

605DGT/2

006050302 175 g



297,00 €
171,00 €



Electronic torque wrench with reversible ratchet for right-/left-hand tightening torque accuracy $\pm 3\%$ (right-hand) $\pm 4\%$ (left-hand)

UNI EN ISO 6789

1/4"

- Dual measurement mode: peak hold and track
- Power supply: 1 1.5V AAA battery (included)



- Light indicators and an intermittent sound inform user that preset torque has been reached

Nm	Kgfm	lbf.in	■	L (mm)	
4÷20	0,4÷2	35÷177	1/4"	210	0,01

677/C



Break-back torque wrenches with push-through ratchets, for right-hand and left-hand tightening, torque accuracy: ±4% in case

The break-back torque wrench, Beta 677, is particularly suitable for heavy-duty use at high torques. The break-back mechanism informs the user that the set torque has been reached through the bending of the wrench at the joint by approximately 20°.



- Wrench composed of two parts: lever with ratchet and break-back system with torque adjustment



677/C800

UNI EN ISO 6789

3/4"

	Nm	kgfm	lbf.ft	■	L (mm)	▬▬▬	⚖ kg	📄	€
677/C600	120÷600	12÷60	100÷450	3/4"	1059	10	6,0	006770607	1.210,00€ 699,00 €
677/C800	200÷800	20÷80	150÷600	3/4"	1319	10	6,7	006770612	1.260,00€ 725,00 €
677/C1000	300÷1000	30÷100	200÷750	3/4"	1554	20	7,4	006770616	1.335,00€ 769,00 €

605E

Click-type torque wrenches with reversible ratchets for right-hand and left-hand tightening torque accuracy: ± 6%



UNI EN ISO 6789

1/4"

	Nm	kgfm	lbf.in	■	L (mm)	▬▬▬	⚖ g	📄	€
605E/5	1÷5	0,1÷0,5	10÷45	1/4"	190	0,05	180	006050105	248,00€ 142,00 €
605E/10	2÷10	0,2÷1,0	18÷90	1/4"	190	0,1	180	006050110	259,00€ 149,00 €

680

Electronic digital torque meter for testing calibration

- For testing calibration of screwdrivers and torque wrenches, clockwise/anticlockwise operation
- Accuracy: ± 1% of read value
- Colour LCD display, 4 digits
- 3 units of measurement: Nm - lbf.ft. - lbf.in
- Operating modes: Click, Dial, Track
- Enables setting of 15 different control parameters
- With USB/Micro-USB cable for PC connection and data transmission
- Power supply with EU, UK, US & AU adaptors
- Software for issuing TEST REPORTS



680/3

680/350

680/2100

680/30

680/3 3.210,00€
1.814,00 €
 006800000
 1,4 kg Nm 0,1÷3 **1/4"**

680/30 3.170,00€
1.814,00 €
 006800003
 1,4 kg Nm 1,5÷30 **40 mm**

680/350 3.180,00€
1.814,00 €
 006800035
 2,6 kg Nm 10÷350 **1 1/2"**

680/2100 4.730,00€
2.690,00 €
 006800210
 3,5 kg Nm 200÷2100 **27 mm**



1150HPC

Heavy duty universal pliers with cutting edges made of sintered steel

- The decentralized pin allows the fulcrum to be closer to the cutting point, thereby resulting in an improved lever effect.
- Perfect alignment of the nose and the thin profile allow the pliers to be used in very small areas.
- The body of the pliers is made of a reliable molybdenum steel which has been heat treated in order to be flexible and resistant so as to guarantee a safe grip in any moment.



1150HPC
011500618 ~~76,00 €~~ **42,00 €**

Shearing stress - static test =	-73%
Average life of cutting edges = (test ISO 5744)	+127%
Hardness of M2 steel cutting edges =	65HRC



**PATENTED
ABSOLUTELY
GROUNDBREAKING
REMARKABLE CUTTING
CAPACITY**

THE DECENTRALIZED PIN ALLOWS THE FULCRUM TO BE CLOSER TO THE CUTTING POINT, THEREBY RESULTING IN AN IMPROVED LEVER EFFECT

1169BM/D3
011690133 ~~113,50 €~~ **65,00 €**

Set of 1 combination pliers, 1 long needle nose pliers and 1 diagonal cutting nippers



1169GBM/D2
011690272 ~~69,00 €~~ **39,00 €**

Set of 1 combination pliers, 1 long needle nose pliers and 1 diagonal cutting nippers, bi-material handles, industrial finishing



1048N



SLIP JOINT PLIERS, BOXED JOINTS, OUTSTANDING GRIP AND AMAZING HANDLING

Slip joint pliers, slip-proof PVC coated handles

New tooth geometry for effective, safe grip on hexagonal and cylindrical profiles



Up to eight adjustment options

Extraordinary handling and comfort thanks to the large contact surface of the handle

Induction hardened teeth for longer durability

- Triangular section grip for a more comfortable contact surface
- Tapered head allowing access to small spaces
- Case-hardened nail for improved wear resistance
- The handles coated with innovative slip-proof PVC ensure a secure grip.
- Phosphated finish
- Made from chrome-vanadium steel

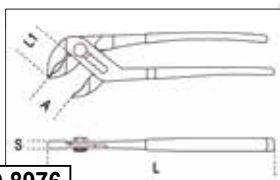

DIN ISO 8976

1048N/D3

010480923

~~131,50 €~~
75,00 €

Set of 3 slip joint pliers



1048N

	L mm	A Max mm	L1 mm	S mm	g		€
1048N 175	175	36	31	11	189	010480910	36,00 € 21,00 €
1048N 250	250	46	38	13	354	010480915	38,50 € 23,00 €
1048N 300	300	60	44	14,8	554	010480920	57,00 € 33,00 €
1048N 400	400	96	81	19	1180	010480940	89,00 € 52,00 €

1048VN

Slip joint pliers, boxed joints, with orange lacquered finish



	L mm	A Max mm	L1 mm	S mm	g		€
1048VN 175	175	36	31	11	189	010480111	30,50 € 17,00 €
1048VN 250	250	46	38	13	354	010480116	34,50 € 20,00 €
1048VN 300	300	60	44	14,8	554	010480121	50,50 € 29,00 €

1044N 250

010440025

~~33,50 €~~
19,00 €

Slip joint pliers, phosphated, overlapping joint, non-slip PVC-coated handles

L mm	A Max mm	L1 mm	S mm	g	
250	46	48	8,5	330	010440025



1169N/D4

011690024

~~129,00 €~~
75,00 €

Set of 1 heavy-duty combination pliers, 1 long needle nose pliers, 1 cutting nippers, chrome-plated, and 1 slip joint pliers with boxed joints, phosphated



1082 160 mm

1150 180 mm

1166 160 mm

1048N 250 mm

1031/S4

010310000

~~129,50 €~~
73,00 €

Set of 4 circlip pliers

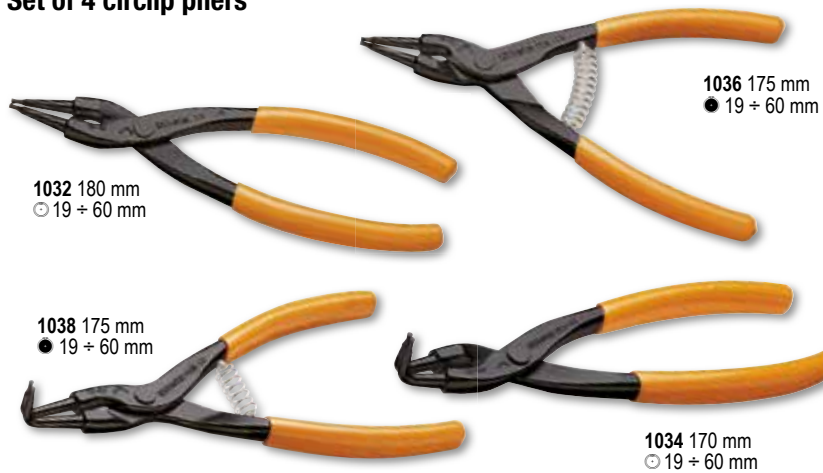

1032 180 mm
⊙ 19 + 60 mm

1036 175 mm
● 19 + 60 mm

1038 175 mm
● 19 + 60 mm

1034 170 mm
⊙ 19 + 60 mm

999ESD/B4

009990040

NEW!

~~109,00 €~~
43,00 €

Set of 4 ESD spring tweezers, acid and magnetic resistant



1052

Adjustable self-locking pliers, concave jaws



	L mm	∅ Max mm	Wt g	Code	€	€
1052/140	140	22	175	010520014	31,00 €	18,00 €
1052/190	190	36	360	010520019	34,50 €	20,00 €
1052/240	240	42	590	010520024	37,50 €	22,00 €
1052/300	300	55	900	010520030	62,00 €	36,00 €



1068

010680000

~~140,50 €~~
80,00 €

Adjustable self-locking pliers with hammer face

The self-locking pliers with 1 kg sliding hammer face is ideal for pulling stud bolts, broken screws and sheets, especially in the car repair industry.



260 mm

365 mm

1 kg

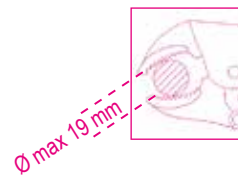

412/SP25 ~~215,50 €~~
124,00 €

004120425

Set of 25 twist drills with cylindrical shanks in case

∅ 1÷13 x 0,5 mm

R ≤ 800 N/mm²
HV ≈ 750÷820
DIN 338



≡ 110x190x55 mm



415/SP19 ~~214,00 €~~
120,00 €

004150419

Set of 19 twist drills with cylindrical shanks in case

∅ 1÷10 x 0,5 mm

Voor het boren in roestvast staal, staallegering, gietijzer, halfzacht staal en lichte legeringen



≡ 115x170x40 mm



416/SP19 ~~151,50 €~~
86,00 €

004160419

Set of 19 drills, HSS, specially ground with double penetration cone

∅ 1÷10 x 0,5 mm

HIGHER CUTTING CAPACITY



≡ 115x170x40 mm



418/K3 ~~38,50 €~~
22,00 €

004180103

Kit of masonry chisels with SDS-plus connection

Kit contents:

- 1 pointed chisel
- 1 narrow flat chisel, 20 mm
- 1 wide flat chisel, 40 mm



420D/SP8 ~~20,90 €~~
12,00 €

004200200

Set of twist drills with cylindrical shanks, for wood, 2 cutters, centre guide drill bits

- ∅ 3-4-5-6-7-8-9-10 mm



≡ 98x158x18 mm

437P

004370003

~~54,50 €~~
31,00 €

Thread dresser, for repairing internal and external, right-hand and left-hand threads

- P 0,80-1,00-1,25-1,50-1,75-2,00-2,50-3,00 mm



230 mm

437U/09

004370550

~~396,00 €~~
228,00 €

Assortment for repairing damaged threads in metal case

- M5X0,8
- M6X1,0
- M8X1,25
- M10X1,5
- M12X1,75



370x230x55 mm

451/C8

004510308

~~382,00 €~~
219,00 €

Assortment of 8 hole cutters, HSS, entirely ground

- Minimum thickness: 4 mm



270x225x70 mm

446/C110

004460060

~~1.016,00 €~~
549,00 €

Assortment of 105 chrome-steel taps and dies, metric thread, and 5 accessories for car repair jobs, in wooden case

III	I	II	III
430 M mm	433 M mm	440/440A M mm	441/441A M mm
2x0,4	6x0,75 - 7x0,75	2x0,4	6x0,75 - 7x0,75
3x0,5	8x0,75 - 8x1	3x0,5	8x0,75 - 8x1
4x0,7	9x0,75 - 9x1	4x0,7	9x0,75 - 9x1
5x0,8	10x0,75 - 10x1	5x0,8	10x0,75 - 10x1
6x1	10x1,25 - 11x0,75	6x1	10x1,25 - 11x0,75
7x1	11x1 - 11x1,25	7x1	11x1 - 11x1,25
8x1,25	12x0,75 - 12x1	8x1,25	12x0,75 - 12x1
9x1,25	12x1,25 - 12x1,5	9x1,25	12x1,25 - 12x1,5
10x1,5	14x1 - 14x1,25	10x1,5	14x1 - 14x1,25
11x1,5	14x1,5 - 16x1	11x1,5	14x1,5 - 16x1
12x1,75	16x1,5 - 18x1,5	12x1,75	16x1,5 - 18x1,5
14x2		14x2	
16x2		16x2	



- 435/0 444/1 436/1
- 435/3 444/2

500x337x60 mm

1599F

Parallel bench vices, forged

Fully steel cast. Milled and hardened jaw surface. Front opening. High clamping depth.

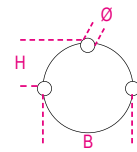
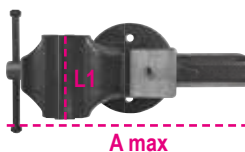

	L mm	BxH mm	Ø mm	A max mm		€
1599F/100	100	92x46	11	125	015990100	380,00 € 219,00 €
1599F/125	125	108x54	13	150	015990125	485,00 € 274,00 €
1599F/150	150	125x62	13	200	015990150	681,00 € 384,00 €
1599F/175	175	140x70	15	220	015990175	930,00 € 527,00 €

1691MG

Measuring tapes with fixed magnets

- Shock-resistant ABS casings
- Steel tapes
- Precision class: II

	L m	S m		€
1691MG/5	5	25	016910405	16,80 € 9,50 €
1691MG/8	8	25	016910408	23,50 € 13,00 €
1691MG/10	10	25	016910410	24,90 € 14,00 €



1650

Sliding gauge made from hardened stainless steel

- Reading to 0.05 mm
- Spring locking

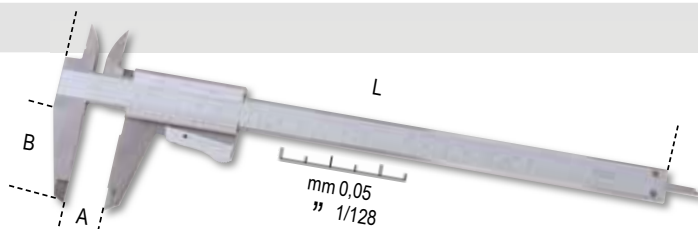

	A Max mm	L mm	B mm	G mm		€
1650/150	150	235	40	0,05-1/128	016500001	71,00 € 41,00 €
1650/200	200	290	49	0,05-1/128	016500002	93,50 € 54,00 €

DIN 862
UNI EN ISO 13385-1



1651DGTB

Digital vernier, reading to 0.01 mm

- Screw slider locking
- Mm/inch conversion
- Zero setting at any position
- Square depth rod up to 300 mm
- In hard plastic case

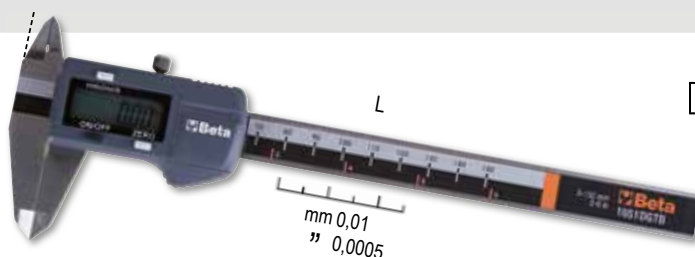

DIN 862
UNI EN ISO 13385-1



	A Max mm	L mm	B mm	G mm		€
1651DGTB 150	150	235	40	0,01-0,0005	016510211	120,00 € 69,00 €
1651DGTB 200	200	285	50	0,01-0,0005	016510212	156,00 € 90,00 €
1651DGTB 300	300	400	60	0,01-0,0005	016510213	204,00 € 119,00 €

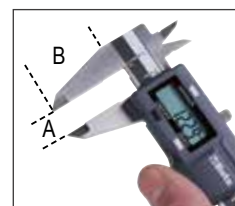

1674C

016740230

~~22,10 €~~
13,00 €

Carpenter's combination square with steel blade

- Double mm scale
- Surface level



1693L 40

016930040



174,50 €
101,00 €

Laser distance meter, multipurpose, 40 m, with positioning levels

MEASUREMENTS:

- Single distance measurement
- Continuous measurement or minimal measurement

Functions:

- Addition/subtraction
- Area measurement
- Volume measurement
- Variable indirect measurement (Pythagorean measurement)
- Tilt measurement

Features:

- Auto power off
- Battery life: up to 5,000 measurements
- Soft cloth case (included)

TECHNICAL DATA:

- Measurement range: 0.05 ÷ 40 m (0.2in ÷ 131ft)
- Scale selection: m, in, ft
- Measurement accuracy: ±1.5 mm (± 0.06 in)
- Laser class: 2
- Max. storage: 99 units
- Batteries: AAA 2 x 1.5V

POSITIONING LEVELS

40 m

IP54



1696T

Spirit levels with magnetic base, made from profiled aluminium, with three unbreakable vials

- V-profiled base
- Precision: 0.5 mm/m
- Complete with vertical reading window



	L mm	H mm	S mm		€
1696T 600	600	66	28	016960506	88,00 € 49,00 €
1696T 800	800	66	28	016960508	98,00 € 55,00 €
1696T 1000	1000	66	28	016960510	103,50 € 58,00 €
1696T 1200	1200	66	28	016960512	128,50 € 72,00 €

1760/IR500

017600350

186,50 €
105,00 €



Digital infrared thermometer with dual laser aiming system



Technical Data:

- Temperature range: -50 ÷ 500 °C (-22 ÷ +932 °F)
- Display resolution: 0.1 °C (0,1 °F)
- Emissivity: 0.1 ÷ 1 adjustable
- Accuracy: -50 °C ÷ +20 °C (+/- 3 °C); 20 ÷ 500 °C (+/-2% or 2 °C)
- Optical resolution (D:S): 12:1
- Auto power off: ca. 10 seconds
- Operating temperature: 0 °C ÷ 50 °C
- Storage temperature: -20 °C ÷ 60 °C
- Power supply: 1 9V battery

1760PA/AC-DC

017600000

387,00 €
219,00 €



Amperometric clamp and digital multimeter

A: AC/DC
V: AC/DC

SPECIFICATIONS:

- DC voltage: 0.1mV ÷ 600V
- AC voltage: 0.1mV ÷ 600V
- AC current: 0.01A ÷ 1000A
- DC current: 0.01A ÷ 1000A
- Resistance: 0.1Ω ÷ 40MΩ
- Capacity: 0.001nF ÷ 40 μF
- Frequency: 0.001kHz ÷ 4kHz
- Temperature: -40°C ÷ 1000 °C -40°F ÷ 1832°F

1000 A



17600HM/2

017600027



~~429,00 €~~
241,00 €

NEW!

Megohmmeter for high voltage insulating testing

Our megohmmeter is synonymous with technology and accuracy for really professional measurements. With an insulating capacity up to 100 GΩ at 1000V voltage, this instrument is ideal for professional, accurate measurements in all electrical applications. Particularly suitable for electric and hybrid cars.

Features:

- Insulation test up to 100 GΩ with 1000V voltage
- Large direct reading display, backlit
- Water protection: IP67
- Rubber terminal base for enhanced operating comfort
- Double insulated terminals CAT IV 600V, CAT III 1000V
- Ideal for electric and hybrid cars



PARTICULARLY SUITABLE FOR
ELECTRIC AND HYBRID CARS

	Measuring range	Basic accuracy
AC voltage:	10V - 600V	±(1.5% +5)
DC voltage:	0V - ±600V	±(1.5% +5)
Resistance:	0.01Ω - 200Ω	±(2% +5)
Insulation test @1000V:	0.01Ω - 100GΩ	±(1.5% +5)
Frequency:	1~1KHz	±(0.1% +3)

1760/RMS

017600020

~~348,00 €~~
201,00 €



Industrial digital multimeter accurate and sturdy, in a 6-mm co-moulded shell, with antislip, shockproof outer rubber part

- Water protection IP67
- Protection up to 1000V
- Tested for accidental falls up to 2 m
- Protected inlets
- Autoranging
- Large direct reading display, backlit, blue
- K type temperature probe (included)
- Self-power down
- Rubber terminal base for enhanced operating comfort
- Double insulated terminals, 1000V, 1 m long
- Supplied in a soft case
- CAT IV 600V/ CAT III 1000V
- Actual effective value TRUE RMS



IP67



	Measuring range	Base accuracy
AC/DC voltage	110mV - 600V ±0.8%	- ±2% rdg
AC/DC current	110µA - 10A ±1.5%	- ±2% rdg
Resistance	110Ω - 40MΩ ±1.2%	- ±2.5% rdg
Capacity	11nF - 40mF ±5%	- ±10% rdg (up to 11mF)
Frequency	1100Hz - 110 MHz ±1.2%	- ±1.5% rdg
Temperature	-32°C - +1000°C ±3%	- ±5% rdg
Diode test	3V DC ±10% rdg	
Continuity test	<30 Ω	

1760S

017600022

~~100,00 €~~
58,00 €



Compact digital multimeter

- IP40 protection
- Autoranging
- Large direct reading display, backlit, blue
- Self-power down
- Low battery indication
- Supplied in a soft case
- CAT III 600V
- TRUE RMS (actual effective value)



IP40



Measurable parameters:
DC voltage: 200 mV-2/20/200/600V
AC voltage: 100/600V
DC current: 200 mA-10 A
AC current: 0,01-10 A
Resistance: 200Ω - 2/20/200 kΩ - 2 MΩ
Diode test: 0.4 ÷ 0.7
Power supply: 2 1.5V batteries, type AAA

1370

**Mechanic's hammers
wooden shaft**



HICKORY UNI 7778 DIN 1041

	g	g		€
1370/300	300	439	013700053	17,90 € 10,00 €
1370/500	500	669	013700055	21,90 € 13,00 €
1370/800	800	949	013700058	28,50 € 17,00 €
1370/1000	1000	1180	013700060	34,00 € 20,00 €
1370/1500	1500	1722	013700065	39,00 € 23,00 €
1370/2000	2000	2181	013700070	46,00 € 27,00 €

1370T

**Mechanic's hammers
fibre shaft**



	g	g		€
1370T/300	300	452	013700630	26,50 € 15,00 €
1370T/500	500	663	013700650	29,00 € 17,00 €
1370T/800	800	1017	013700680	31,00 € 18,00 €
1370T/1000	1000	1279	013700700	39,00 € 23,00 €
1370T/1500	1500	1740	013700750	45,50 € 26,00 €

32AU

000320160

~~62,50 €~~
36,00 €

Automatic centre punches



L 150 mm

Ø 3 mm

1390

**Soft face hammers,
wooden shaft**



UNI 7784

	Ø mm	g		€
1390/22	22	134	013900022	21,90 € 13,00 €
1390/28	28	230	013900028	27,00 € 16,00 €
1390/35	35	365	013900035	37,00 € 21,00 €
1390/45	45	689	013900045	59,00 € 34,00 €
1390/60	60	1462	013900060	99,50 € 58,00 €

33NR

Number punches

- For engraving steel with resistance R up to 80 kg/mm²
- Kit of 9 punches: numbers 0 to 9

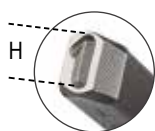

	H mm	L mm	A mm		€
33NR 3	3	61	6,35	000330003	25,00 € 14,00 €
33NR 4	4	62	7,93	000330004	30,50 € 18,00 €
33NR 5	5	62	7,93	000330005	30,50 € 18,00 €
33NR 6	6	68	9,52	000330006	37,00 € 21,00 €
33NR 8	8	71	12,7	000330008	54,00 € 31,00 €

33LT

Letter punches

- For engraving steel with resistance R up to 80 kg/mm²
- Kit of 27 punches: letters A to Z + &



	H mm	L mm	A mm		€
33LT 3	3	61	6,35	000330023	70,50 € 41,00 €
33LT 4	4	62	7,93	000330024	86,00 € 50,00 €
33LT 5	5	62	7,93	000330025	86,00 € 50,00 €
33LT 6	6	68	9,52	000330026	105,50 € 61,00 €
33LT 8	8	71	12,7	000330028	158,50 € 91,00 €

1547/C6

015470006

~~331,00 €~~
186,00 €

Dummy ball bearing extractors

Bearings:
1547/1
6011-6014, 6206-6211, 6303-6308, 6403-6405

1547/2
6004-6010, 6200-6205, 6300-6304

- Quick, safe extraction



1545/C5M

015450011

~~644,00 €~~
365,00 €

Puller 1542/1 with 5 extractors 1544



265x180x45 mm

	A mm	C mm
1544/1	9+12	0,80
1544/2	13+17	1,15
1544/3	16+21	1,70
1544/4	20+25	1,65
1544/5	25+30	2,00



1430/S5

014300105

~~29,50 €~~
17,00 €

Set of 5 tapered extractors for broken screws and studs, made from hardened steel in case

1430/1-1430/2-1430/3
1430/4-1430/5



1500N

Universal pullers with 2 sliding legs

- Special leg design, for automatic leg locking under loading conditions.
- For both external and internal use
- Legs can be moved along crosspiece.

	A min+max mm	L mm	L1 mm	● mm	A1	015000600	€
1500N/0	18÷65	70	100	15	110	015000600	88,00 € 51,00 €
1500N/1	23÷70	100	130	17	130	015000601	92,00 € 53,00 €
1500N/2	23÷100	100	130	17	160	015000602	99,50 € 57,00 €
1500N/3	35÷140	150	190	20	230	015000603	165,50 € 96,00 €
1500N/4	35÷190	150	190	20	280	015000604	178,00 € 102,00 €
1500N/5	43÷250	205	295	27	360	015000605	343,00 € 197,00 €
1500N/6	43÷320	205	295	27	430	015000606	372,00 € 215,00 €

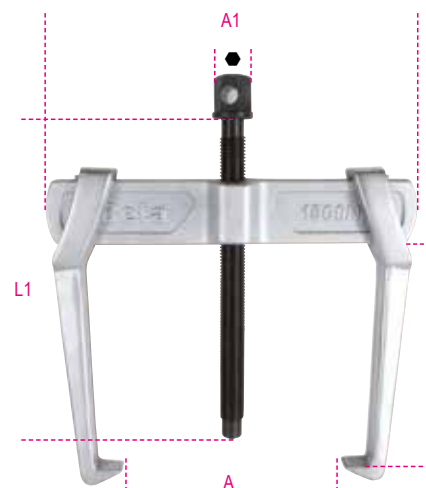

332

Mini pipe cutter for copper and light alloy pipes



	L mm	Ø mm "		€
332	59	3÷16 1/8"÷5/8"	003320001	27,00 € 15,00 €
332/2	63	3÷28 1/8"÷1"1/8"	003320003	30,50 € 17,00 €

376

Pipe wrenches, Swedish pattern, 90° flat jaws



	L mm	Ø "	Ø mm		€
376 320	320	1" gas	34	003760032	57,00 € 32,00 €
376 410	410	1 1/2" gas	49	003760041	75,00 € 43,00 €
376 550	550	2" gas	60	003760055	116,50 € 65,00 €
376 630	630	3" gas	90	003760063	212,00 € 120,00 €

342

Ratchet-type shears for plastic pipes

~~61,00 €~~
35,00 €

003420030 1,5 Kg



Ø 0÷42 mm
1"5/8

363

Heavy duty pipe wrenches made from light alloy



	L mm	Ø "	Ø mm		€
363 350	350	2" gas	60	003630035	77,50 € 45,00 €
363 450	450	2 1/2" gas	76	003630045	104,50 € 61,00 €
363 600	600	3" gas	90	003630060	176,50 € 102,00 €
363 900	900	5" gas	140	003630090	331,00 € 193,00 €
363 1200	1200	6" gas	165	003630120	351,00 € 204,00 €

1750KG10

~~225,00 €~~
130,00 €

017500100 10 Kg

Lever-operated grease gun, 10 kg, with high-pressure hose, 2 m

- Complete with swivel fitting, to avoid choking hose
- Die-cast aluminium pump body with check valve

3 different pressure levels available:

- 4 g at 275 bar
- 7 g at 206 bar
- 9 g at 137 bar



312,5 mm

345SB

~~27,00 €~~
15,00 €

003450010

Deburrer with revolving replacement blade

- For copper, light alloy and PVC pipes.
- Supplied with 2 blades

L mm
150



1750

~~50,00 €~~
29,00 €

017500500

Lever operated grease guns, 500 cc

550 BAR



WIRELESS RECHARGEABLE ((☉))



Based on improved LED technology, longer battery life, shorter charging time, painstaking attention to materials and ongoing search for innovative solutions, Beta's work lamps mean an outstanding combination of design, functionality and performance.

The lighting family comprises a wide range of products designed to satisfy all users' requirements, ranging from inspecting small pipes to lighting large working areas.

A comprehensive range designed to allow professionals to work at their best, in any sector and under any condition.



1833XSW

018330011

~~54,50 €~~
31,00 €

LED inspection torch, wireless rechargeable

- Two brightness settings: LED SMD, 250 - 80 Lumen
- Rechargeable battery: 3.7V 700 mAh., 2.59 Wh Li-ion
- Two charging modes:
 - wireless base 1839BRW
 - power supply with USB-C port
- Charging time:
 - 2h with wireless charging base
 - 2h with power supply
- Battery life: 2-8h
- LED battery level indicator
- Magnets on base and back
- Belt clip
- USB-C cable included
- IP54
- IK07



L 145 mm



1833MW

018330013

~~99,50 €~~
57,00 €

High-brightness LED torch, wireless rechargeable

- Four brightness settings: LED SMD, 1000 - 400 - 30- 5 Lumen
- Rechargeable battery: 3.7V 2600 mAh, 9.62 Wh Li-ion
- Two charging modes:
 - wireless base 1839BRW
 - power supply with USB-C port
- Charging time:
 - 6h with wireless charging base
 - 4h with power supply
- Battery life: 2-200h
- 3-LED battery level indicator
- Magnet on back
- USB-C cable included
- IP68
- IK07



L 160 mm



WIRELESS RECHARGEABLE (())

1838SW

018380142

~~110,50 €~~
64,00 €



Rechargeable, articulated LED inspection lamp and wireless charging

- Rechargeable 3.6V 3.350mAh Li-ion battery
- 2 charging modes:
 - wireless 1839BRW base
 - power supply with USB-C port
- Charging time:
 - 6.5h with wireless charging base
 - 4.5h with power supply
- Battery life: - front: 3-5h
- spot (head): 7h
- 3-LED battery level indicator
- Base can be rotated 180°
- Nonslip rubber body
- Double swinging hook
- Magnets on base and back
- IP65
- IK07



- **Dual light emission:**
 - front: LED COB, 3 light intensities: 250 - 500 - 1000 lumens
 - spot (head): LED SMD, 200 lumens



1836AW

018360051

~~82,00 €~~
48,00 €



Rechargeable wireless LED headlamp, dual brightness

- Rechargeable battery:
 - Li-Ion 3.7 V, 1500 mAh, 5.55 Wh
- USB-C port
- Supplied with USB-C cable
- Charging time:
 - 2.5 h with power supply
 - 4.5h with wireless charging base
- Battery life: front: 4-18 h
head (spotlight): 4 h
- IP65
- IK07



- **Dual light emission:**
 - front: 3 light intensities, LED COB, 30 - 200 - 400 lumens
 - head (spotlight): LED COB, 400 lumens



1838POCKET

018380080

~~77,50 €~~
45,00 €



Articulated pocket LED spotlight, with dual light beam and wireless charging

- Rechargeable 3.7V 2600mAh Li-ion battery
- 2 charging modes:
 - wireless 1839BRW base
 - power supply with USB-C port
- Charging time:
 - 4.5 h with wireless charging base
 - 4 h with power supply
- Battery life: - main light: 3-9h
- spot light: 4.5 h
- 3-LED battery level indicator
- Can be rotated 210°
- Nonslip rubber body
- Magnetic base
- 1 magnet on base
- Supplied with a USB-C cable
- IP65
- IK07



- **Dual light emission:**
 - main light: LED COB, 3 light intensities: 160 - 400 - 800 lumens
 - spot light: LED SMD, 250 lumens
- **Lighting angle:**
 - main light: 160°
 - spot light: 18°



WIRELESS RECHARGEABLE ((☉))

1839BRW

104,50 €
61,00 €



Wireless charging base, compatible with 1838POCKET, 1838SW, 1836AW, 1833XSW, 1833MW inspection lamps

- Two charging positions with magnetic connection, for simultaneous use
- With pull-out support for wireless mobile phone charging
- Charging status LED indicator
- Max. input: 10W x2
- Input: AC 100-240V 50/60Hz
- Output: DC 12V 1.5A
DC 9V 2A
DC 5V 3A
- USB-C port
- IP20
- IK07



- **Can be hung on wall through:**
3 strong magnets on back
2 screw holes



KIT WIRELESS ((☉))

The kit comprises products performing different functions. What is more, wireless technology makes it possible to do away with cables, which results in a more convenient and tidier charging base. Wireless technology means one of the latest innovations for work lighting and allows one's instruments to be easily charged.



1839W/K1

292,00 €
152,00 €

018390810

Kit of wireless lamps 1838SW and 1838POCKET, with compatible charging base 1839BRW

- wireless rechargeable, articulated LED inspection lamp 1838SW
- wireless rechargeable, articulated pocket LED spotlight 1838POCKET
- wireless charging base 1839BRW, compatible with the lamps of the kit

297,00 €
155,00 €

1839W/K2

018390820

Kit of wireless lamps 1838SW and 1836AW, with compatible charging base 1839BRW

- wireless rechargeable, articulated LED inspection lamp 1838SW
- wireless rechargeable LED headlamp 1836AW
- wireless charging base 1839BRW, compatible with the lamps of the kit



1833

High-brightness LED torch, made of sturdy anodized aluminium

- Adjustable focus
- 2 brightness settings
- IP66



Battery life 10.0 h - L 150 mm

1833 S

~~43,50 €~~
24,00 €

018330002



Battery life 7.5 h - L 162 mm

1833 M

~~54,50 €~~
32,00 €

018330003

1837C



Rechargeable LED spotlight for building yards

- 3 brightness settings
- battery charger: input: 100-240V AC - 50/60Hz; output: 15V 1.5A
- charging time: 4 hours
- 3-LED charge indicator
- can rotate up to 180°
- IP65
- IK07



500/1000/2100 lumen

1837C/2100

~~216,50 €~~
127,00 €

018370210



1100/2100/4300 lumen

1837C/4300

~~318,00 €~~
184,00 €

018370430

1837S

~~70,50 €~~
39,00 €

018370500

Telescoping tripod for worklight

- Made of metal
- Adjustable height: 70÷155 cm
- Compatible with items 1837C and 1838FLASH



1838FLASH

~~384,00 €~~
208,00 €

018380300

Rechargeable, ultracompact spotlight, designed to offer the best possible solution for each use



- IP65 - without external power supply
- Dual brightness: 300/720 lumens
- Lithium polymer battery 7.4 V 4000 mAh



12V



230V

5 m



85x100x155 mm



360°

1/4"



1838/11LED

~~188,00 €~~
103,00 €

018380111



Rechargeable inspection lamp with ultra-high brightness LEDs, lithium polymer battery

- Compact body made of antislip rubber
- With charging station, 110-230Vac



With head LED



With multidirectional head LED



Swinging hook



<20%



1838PN **NEW!**
 018380008 ~~64,00 €~~
33,00 €

Rechargeable LED pen light

- **Dual light emission: main and spot**
- 3 light intensities:
 main COB LED 350 - 175 lumens
 spot: SMD LED 120 lumens
- Rechargeable battery: Li-Ion 3.7 V, 1600 mAh
- Charging time: 2.5h
- Battery life:
 main: 6/3h
 spot: 6h
- Magnetic base
- Belt clip/magnetic pocket
- IP65
- IK07
- USB-C cable included



1838COMPACT **NEW!**
 018380011 ~~71,50 €~~
39,00 €

Rechargeable, compact LED lamp

- **Dual light emission: main and spot**
- 3 light intensities:
 main COB LED 300 - 120 lumens
 spot SMD LED 150 lumens
- Rechargeable battery: Li-Ion 3.7 V, 1500 mAh
- Charging time: 2.5h
- Battery life:
 main: 7/3.5h
 spot: 6h
- Can be hung, with nonslip, shockproof rubber body
- Hook can be rotated 360°
- Magnetic base can be rotated 180°
- Belt clip/pocket
- IP65
- IK07
- USB-C cable included



60,8x26x120 mm

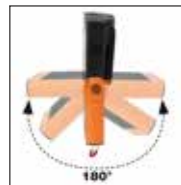

1838SLIM
 018380221 ~~83,00 €~~
46,00 €

Rechargeable, articulated slim 3-LED inspection lamp

- Magnetic base
- Charging time: 2.5h
- Battery life: 2-4h/ spot 3h

Triple light emission

- front: 100/200 lumens
- back: 180 lumens
- spot (head): 80 lumens

L 307 mm



1838AM
 018380400 ~~123,00 €~~
68,00 €

Rechargeable LED inspection lamp, with double light emission, articulated, can be rotated 180°, with swivel magnetic base and hook

Double light emission:

- front: LED COB, 60-700 lumens, can be adjusted with potentiometer spot (head): LED SMD, 120 lumens, ON-OFF switch
- Rechargeable 3.6V 2600mAh Li-ion battery
- With USB-C port
- Supplied with 100-240V / 50-60Hz charger
- Charging time: 4h
- Battery life: front: 2.5-16h
 spot (head): 10h
- 3-LED battery level indicator
- Magnetic base (with neodymium magnet), can be rotated 90°
- Swivel base hook
- IP54
- IK07

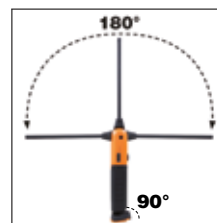

- Articulated, can be rotated 180° (± 90° compared to axis)



L 405 mm

1741TR

017410410

~~47,50 €~~
25,00 €

NEW!

Riveting pliers with rotating head, supplied with 4 interchangeable nozzles

Ø mm	2,4	3,2	4	4,8
Aluminium	•	•	•	•
Steel	•	•	•	
Inox	•	•	•	



L 285 mm



1741

017410003

~~43,50 €~~
24,00 €

Riveting pliers with 4 interchangeable nozzles

Ø mm	2,4	3,2	4	4,8	5
Aluminium	•	•	•	•	•
Steel	•	•	•	•	•
Inox	•	•	•		



L 260 mm



1741P

017410303

~~60,50 €~~
33,00 €

Heavy-duty riveting pliers supplied with 4 interchangeable nozzles

Ø mm	2,4	3,2	4	4,8	5
Aluminium	•	•	•	•	•
Steel	•	•	•	•	•
Inox	•	•	•	•	•



L 260 mm



1741U

017410450

~~54,00 €~~
31,00 €

Ultra compact riveting pliers with adjustable force with 4 interchangeable nozzles

Ø mm	2,4	3	3,2	4	4,8
Aluminium	•	•	•	•	•
Steel	•	•	•	•	•
Inox	•	•	•	•	



**3 JAWS:
IMPROVED
RIVET GRIP**

L 200 mm



ELECTRICAL TOOLS

BM Group has been designing, manufacturing and distributing connecting parts and electrical installation products since 1958. Quality, safety and reliability have always been BM's key values. Combined with a passion for excellence, these values have allowed the company to develop – step by step – into a benchmark for the electrical material market. In 2018 BM Group was taken over by Beta Utensili. This section comprises an accurate selection of products under the brand name BM, supplementing Beta's product range.

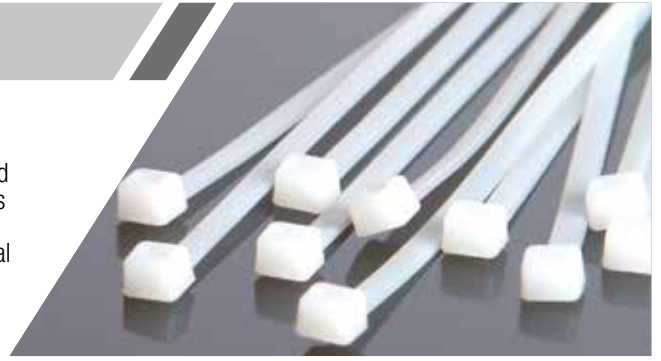

1608/C9 ~~285,00 €~~
 016080045 2 kg **153,00 €**

Pliers with assortment of 450 terminals



420x185x60 mm

1748-N ~~71,00 €~~
 BM1100 **38,00 €**

Fitting tools for nylon cable ties, 2.5 to 4.8 mm in width

- Automatic cutting when set tension is reached.
- With tightening tension adjustment system.
- Materials: glass frame made from polymer and fibreglass, interior parts made from metal



1609B ~~376,00 €~~
 016090101 **215,00 €**

Mechanical crimping pliers

- For noninsulated copper terminals, 10÷120 mm²
- Antislip rubber handle
- Internal "H" section pin for unparalleled punch smoothness
- Made from burnished steel



L 600 mm

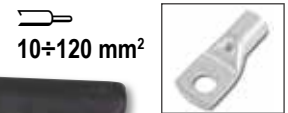

1149F ~~20,50 €~~
 011490010 **12,00 €**

Front wire stripping pliers with cutting blade, self-adjusting

- Self-adjustment to wire diameters
- Adjustable stripping length
- Insulating cutting pressure adjustment
- Built-in cutting device



0,2÷6 mm²

1606T ~~367,00 €~~
 016060005 **197,00 €**

Crimping pliers for tubular terminals, 4-sided crimping

Reduced lever stress



1128FX ~~38,80 €~~
21,00 €
 011280090

Electrician's scissors, straight stainless steel blades, with microteeth, cable cutting groove and crimping pliers for tube terminals

- Articulated belt hook case
- Bimaterial handles
- Anti-loose pin



1128BMX ~~20,80 €~~
12,00 €
 011280051

Electrician's scissors, straight stainless steel blades, with microteeth

- Straight stainless steel blades
- Wire cutting groove
- Microteeth on one side



1128BAX ~~39,80 €~~
22,00 €
 011280088

Double-acting electricians' scissors, with milling profiles in DLC-coated stainless steel

- High blade surface hardness (resistance to abrasion and wear)
- Low coefficient of friction (smoothness and anti-adherence)
- With articulated plastic case

**+HARDNESS
 -COEFFICIENT
 OF FRICTION**



Profile and mill: designed to enlarge holes on plastic, from 13 to 25 mm.



1771BM ~~23,90 €~~
14,00 €
 017710050

Utility knife, 18 mm, 6 spare blades

- Nonslip bi-material handle
- Automatic blade loading
- Blade locking nut for maximum blade stability under stress conditions
- Nonreturn safety slider
- Automatic blade loading



1778SOS ~~38,50 €~~
21,00 €
 017780080

Car service knife with window breaking hammer and seat belt cutter features in case

- With clip and fabric wallet with loop
- Anodized aluminium handle
- Safety blade lock



1772M ~~21,80 €~~
13,00 €
 017720040

Safety utility knife with retractable blade, supplied with 3 blades

- Blade retracts through an automatic spring mechanism
- Die-cast alloy body
- Staple remover built into handle



1778MT MULTIPURPOSE TOOL COMPLETE WITH BITS AND SHEATH



BETA's multipurpose tool stands out from similar commercially available tools with BETA's typical hallmarks: pliers synonymous with matchless quality, sophisticated materials and state-of-the-art technology. The 11 bits, which come in the most popular geometries in the market, make this item ideal for any work environments and conditions, e.g. camping, nautical industry, hunting and DIY.

1778MT

017780055

~~115,50 €~~
65,00 €

Multi-tools complete with bits and sheath

9 tools for a total of 22 functions:

- Combination pliers
- Large blade
- Corrugated blade
- Hacksaw frame
- File
- Tin/Bottle opener
- Scissors
- Bit holder
- Screwdriver for cross head Phillips® screws



11 bits + socket + tweezers



Ruler 100 mm + Ruler, 4"

**SUITABLE
FOR EVERY
SITUATION!**



Easy pull-out of tools



Tool unlock buttons



**COMPACT
AND VERSATILE!**

1777BMT

017770050

~~32,50 €~~
18,00 €

Foldaway knife with trapezoidal blade

- 4 adjustable blade depths
4; 9.5; 15.5; 21.5 mm
- String cutting groove
- Supplied with 3 blades



1726BM

017260050

~~54,00 €~~
30,00 €

Hacksaw frame with quick release blade attachment system

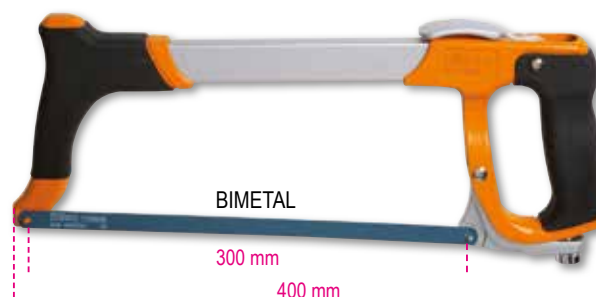
- Sturdy frame for increased firmness
- Nonslip handle
- Quick release lever blade system
- Blade can be tilted up to 45°
- Ergonomic design



THE RANGE OF REELS



Beta's wide, complete range of reels has been designed and developed to satisfy all professionals' requirements. High-resistance spring ensuring remarkable durability and fluidity in use. Shells made of thick polypropylene, for unique shock resistance. Rack device causing automatic cable rewind to stop, easy to disable, to allow continuous traction. Each reel is fitted with a 180° swivel wall-mount bracket and an additional bracket for quick connection and disconnection from the wall-mount support.

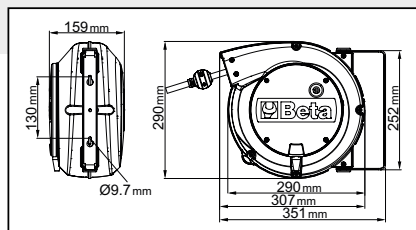

CABLE REEL

- Length of cable out of shell: 1 m
- Rack mechanism can be disabled to keep cable in traction
- Coiled cable length: 15 m



1842 15-H05/LED
 018420821 ~~388,00 €~~
224,00 €

Automatic cable reel with LED inspection lamp, 100-240Vac

- With 230/12V safety transformer
- H05VV-F 2x1.0 mm² cable



1844 15-H05
 018440315 ~~253,00 €~~
146,00 €

Automatic cable reel, with 3Gx1.5 mm² cable

- 3Gx1.5 mm² cable
- With thermal protection switch
- Max. power (rolled up): 1500W (230V-20°C)
- Max. power (unrolled): 2500W (230V-20°C)



1844 15-H05/SCK
 018440316 ~~264,00 €~~
153,00 €

Automatic cable reel, with 3Gx1.5 mm² cable and SCHUKO type socket and plug

- 3Gx1.5 mm² cable
- With thermal protection switch
- Max. power (rolled up): 1500W (230V-20°C)
- Max. power (unrolled): 2500W (230V-20°C)



1845 15-H07
 018450367 ~~521,00 €~~
303,00 €

Automatic cable reel, with 3Gx2.5 mm² cable

- 3Gx2.5 mm² cable
- With thermal protection switch
- Max. power (rolled up): 2000W (230V-20°C)
- Max. power (unrolled): 3000W (230V-20°C)



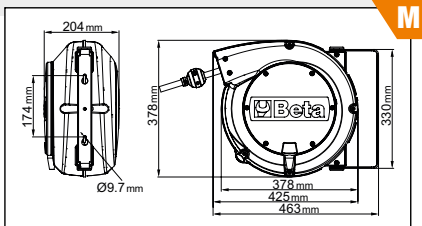
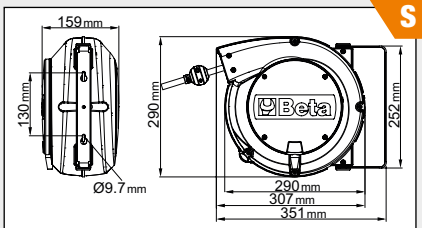

HOSE REEL

- Max. operating pressure: 15 bar
- Braided polyurethane hose
- Operating temperature range: -5 °C / +50 °C

1900S 8X10

019000080

~~195,50 €~~
105,00 €

Automatic spring hose reel with 8x12 mm cable

- Cable length 10 m

Ø GAS BSP 1/4"



1900M 8X15

019000085

~~267,00 €~~
142,00 €

Automatic spring hose reel with 8x12 mm cable

- Cable length 15 m

Ø GAS BSP 1/4"



1900M 10X15

019000115

~~278,00 €~~
153,00 €

Automatic spring hose reel with 10x14 mm cable

- Cable length 15 m

Ø GAS BSP 3/8"



1900M 12X15

019000125

~~363,00 €~~
197,00 €

Automatic spring hose reel with 12x16 mm cable

- Cable length 15 m

Ø GAS BSP 1/2"



NEW!

1273MQ/D6

012730851

~~80,00 €~~
47,00 €

Set of 6 screwdrivers

1274MQ ● 3x100-4x100-5,5x125 mm
1272MQ ⊕ PH0x60-PH1x80-PH2x100 mm

EN 60900



⚡ **1000 V**

1273MQF/D6

012730606

~~102,50 €~~
59,00 €

Set of 6 slim screwdrivers

1274MQ/F ● 3,5x100 - 4,5x100 -
5,5x125 - 6,5x150 mm
1272MQ/F ⊕ PH1x80 - PH2x100 mm

EN 60900



⚡ **1000 V**

1128MQ

011280101

~~58,00 €~~
34,00 €

Electrician's scissors, stainless steel blades, with microteeth

⚡ **1000 V**

IEC 60900



1169MQ/D2

011690152

~~116,50 €~~
65,00 €

Assortment of insulated combination pliers and insulated diagonal cutting nippers

⚡ **1000 V**

EN 60900



11082MQ
160 mm

1150MQ
180 mm

920MQ/C16

009200917

5,2 kg

~~1.066,00 €~~
549,00 €

Set of 9 hexagon sockets, 3 socket drivers for hexagon screws and 4 accessories

⚡ **1000 V**

IEC 60900



	920MQ/A	○	8-10-12-13-14-17-19-22-24 mm
	920MQ/21		135 mm
	920MQ/22		264 mm
	920MQ/55A		
	920MQ/T		
	920MQ/PE	○	5-6-8 mm

16x

420x280x60 mm



12"

C04TSS/7

024003077

63 kg

~~3.050,00 €~~
1.649,00 €
**Mobile roller cab with seven drawers,
 made entirely of stainless steel**

- Seven drawers (570 x 410 mm) with ball bearing slides;
- 6 drawers, 83 mm high;
- 1 drawer, 170 mm high;
- 4 castors Ø 125 mm 2 fixed and 2 steering (two with brakes);
- Front centralized lock;
- Frame made entirely of stainless steel AISI 304
- Castors, supports, ball bearings, drawer interiors and guides made of stainless steel
- Drawer handles made of aluminium

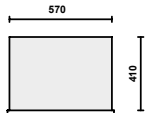

h	max
83 mm	25 kg
170 mm	30 kg

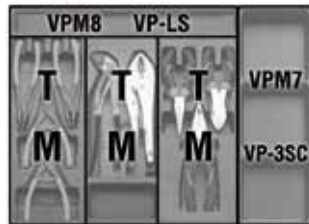
**C20TSS**

021203001

4 kg

~~341,00 €~~
186,00 €
**Five-section cantilever tool box,
 made of AISI 304 stainless steel**

It can be used in critical environments - that is, in areas where the minimum contamination level is not permitted - resistant to rust and the main acids, and can be autoclave sterilized at 121°.



450x200x210 mm

42INOX/SC9

000420387

~~222,50 €~~**127,00 €**
**Set of 9 combination
 wrenches made of
 stainless steel
 with compact support**

8-10-11-12-13-14-15-17-19 mm

**96TINOX/S8**

000961954

~~167,50 €~~**87,00 €**
**Set of 8 offset
 hexagon key wrenches,
 with high torque handles,
 made of stainless steel**

2,5-3-4-5-6-7-8-10 mm

**1293INOX/D8**

012930408

~~98,00 €~~**54,00 €**
**Set of 8 screwdriver
 made of stainless steel**
5x
 1290INOX ● 0,4x2,5x50-0,5x3x75
 0,8x4x100-1,0x5,5x150
 1,2x6,5x150 mm
3x
 1292INOX ⊕ PH0x60-PH1x80
 PH2x100 mm

9860

~~12,20 €~~
6,90 €

098600075

MULTI FOAM

Manual insulating polyurethane foam sealant



Features:

- High-quality professional PU foam
- Good thermal performance
- High resistance to tensile stress, compression and cutting

750 ml



9840BF

~~16,20 €~~
9,50 €

098400029



BETA FIX

Ultra-strength instant assembly adhesive with suction effect



Features:

- Ultra-strength instant adhesion
- High mechanical resistance, final force and elastic module
- Free from isocyanates, phthalates, solvents and silicone
- Permanently elastic, does not shrink, bubble-free, odourless
- Resistant to humidity and weathering
- Adheres primer-free to most substrates, including wet ones

290 ml



9844T/K12-1773U

~~159,50 €~~
76,00 €

098440931

NEUTRAL SIL

12 x Neutral Sil 9844T + 1773U

Features:

- Mildew resistant
- Resistant to UV rays, water and weathering
- Odourless
- Extremely versatile

310 ml

12x



Included in the price
NET VALUE
16,00 €

1773U

65



1749AC

~~45,00 €~~
26,00 €

017490005

High thrust gun for chemical binders



1749A

~~50,50 €~~
29,00 €

017490010

Bonding gun, professional model aluminium tube



9710

LUBRIBETA
7-in-1 multipurpose
unlocking lubricant

1. Unlocking
2. Lubricating
3. Detergent, degreasing
4. Rust protective
5. Deoxidizing
6. Waterproof
7. Antifreezing



		€
9710 (1)	097100040	
9710 (2)	097101040	10,30 € 6,90 €
9710 (3)	097102040	

9752

ZINC 98%
Clear zinc

Highly covering, it is ideal for galvanizing iron parts. Highly adhesive, it forms an elastic film of very light colour, similar to hot galvanizing. Particularly resistant to oxidation, abrasion and weather. Can be overpainted. Does not drip.



		€
9752 (1)	097520040	
9752 (2)	097521040	9,40 € 6,50 €
9752 (3)	097522040	

1773U

017730500

~~27,50 €~~
16,00 €

Multi-purpose silicone tool

- 5 angled rubber tips
- spare scraper blade

5 in 1



9841R

098410020

~~29,00 €~~
15,00 €

RED SEAL

Red acetic-reticulation silicone sealant, resistant to high temperatures, with convenient pressure dispenser (pressure pack)

- Enables permanent elastic sealing.
- Replaces preformed gaskets.
- The convenient dispenser allows easy (one-coated), accurate, uniform spreading of the product.
- Polymerizes by reacting with atmospheric moisture and forms an elastic, durable gasket.
- Ideal for oven and furnace doors, plates, heating systems, outlets, thermostats, pumps, heating pipes, engine parts that are not subject to high pressure and applications that require resistance to high temperatures.
- Perfectly adheres to most non-porous substrates, including glass, coated wood, ceramic and enamel.
- Not suitable for PE, PP, PC, PMMA, PTFE, soft plastics, neoprene and bituminous supports.
- Cannot be painted

200 ml



WITHSTANDS TEMPERATURES UP TO 300 °C

9841N

098410120

~~31,00 €~~
16,00 €

BLACK SEAL

Black acetic-reticulation silicone sealant, resistant to high temperatures, with convenient pressure dispenser (pressure pack)

- Enables permanent elastic sealing.
- Replaces preformed gaskets.
- The convenient dispenser allows easy (one-coated), accurate, uniform spreading of the product.
- Polymerizes by reacting with atmospheric moisture and forms an elastic, durable gasket.
- Ideal for oil sumps, oil pumps, housings, gearboxes, engine parts that are not subject to high pressure and applications that require resistance to high temperatures.
- Perfectly adheres to most non-porous substrates, including glass, coated wood, ceramic and enamel.
- Not suitable for PE, PP, PC, PMMA, PTFE, soft plastics, neoprene and bituminous substrates.
- Cannot be painted.

200 ml



WITHSTANDS TEMPERATURES UP TO 240 °C

1852R1750

018520175

1.775,00 €
989,00 €

Portable induction heater

- Heats and loosens bolts, hubs and bearings without using flames.
- Allows any type of ferromagnetic metal to be heated.

Technical data:

- Input voltage: 230V AC, 50/60 Hz
- Input current: max. 7,5A
- Power: max. 1.75 kW

Benefits

- 1 Time saving: quick, extremely accurate heating
- 2 Fire safety: does not produce flames, maximum operator safety
- 3 Functional: can be used with one hand, and coils can be easily interchanged

Fields of Application:

- Automotive industry
- Industrial maintenance
- Aviation industry
- Naval industry
- Petrochemical industry



**MAXIMUM SAFETY
WITHOUT USING FLAMES**

Included:	
Two front attachable coils, Ø 19 and 26 mm, for loosening nuts	
One flat coil for heating surfaces	
One flexible coil, 800 mm long	



480x370x130 mm

1895

Ultrasonic cleaning tank with special degas function

- Ultrasonic cleaning relies on fluid heating to effectively clean spare parts and metal pieces in general (carburetors, valves etc.)
- Digital display for temperature and cleaning time selection
- Two cleaning modes: "soft" and "normal"
- For normal cleaning, just use water at a temperature of 50/60 °C
- For more accurate cleaning, add non-foaming detergent solutions specific for ultrasonic tanks
- Using the degas mode speeds up air release throughout the tank, thereby improving ultrasonic cleaning efficiency



1895 157



1895 6

018950060

836,00 €
483,00 €

6 l

1895 13

018950130

1.295,00 €
747,00 €

13 l

1895 27

018950270

1.805,00 €
1.044,00 €

27 l

1895 157

018950357

8.310,00 €
4.399,00 €

157 l

NEW!

1895 6 1895 13 1895 27 1895 157

	1895 6	1895 13	1895 27	1895 157
Tank capacity	6 liter	13 liter	27 liter	157 liter
Drain tap	✓	✓	✓	✓
Power	150 Watt	300 Watt	500 Watt	2160 Watt
Heating power	300 Watt	400 Watt	500 Watt	5000 Watt
Temperature range	0+80 °C	0+80 °C	0+80 °C	30+110 °C
Cleaning time range	0-99 minutes	0-99 minutes	0-99 minutes	0-59 minutes
Frequency	40 kHz	40 kHz	40 kHz	28 kHz - 40 kHz
Power supply	220/230V	220/230V	220/230V	220/380V
Dimensions	330x180x310 mm	350x325x320 mm	530x330x380 mm	840x640x750 mm
Tank size	300x155x150 mm	325x235x145 mm	500x300x200 mm	700x500x450 mm



961N

009610030



~~528,00 €~~
307,00 €

NEW!

Electronic videoscope with flexible, rotating probe

- TFT LCD 5" screen
- Supports SD cards
- Video and image recording
- 4 LEDs
- Power supply via USB port (built-in battery)
- Rotating probe
- High resolution

Discover the videoscope, 961N, your versatile partner for all jobs! Based on the probe that can be rotated 360° and the double lit camera reaching the most inaccessible points has never been so easy. Defects and problems can be found easily and accurately. And with the new TFT LCD 5" display and outstanding resolution (1920x1080), you can enjoy sharp, bright images and videos, like never before. Choose the videoscope, 961N, for uncompromised quality.

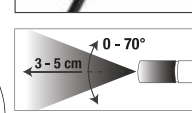
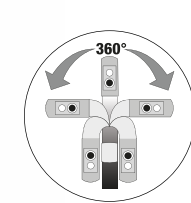

1898/M

018980930

~~17,70 €~~
11,00 €

Pressure sprayer with 1,5 l tank

- Adjustable nozzle with straight jet and mist spray
- Graduated scale (0.5 l - 1 l - 1.5 l)
- Locking lever for continuous jet
- Not for use with hydrocarbons



1898/C

018980940

~~286,00 €~~
175,00 €

NEW!

Wheeled sprayer, 25 l



Particularly useful in a variety of sectors: aeronautics, agriculture, automotive, cleaning, building and road construction, chemical industry, manufacturing industry, mining industry, lube trucks and industrial vehicles, shipbuilding and railway transportation

- dual function: spraying and foaming
- painted steel tank
- stainless steel nozzle
- anti-twisting hose
- tank pressure gauge
- tank level indicator



1898/S

018980932

~~31,00 €~~
19,00 €

Hand pressure pump with 5 l tank

- Stainless steel nozzle
- Locking lever for continuous jet
- Adjustable nozzle with straight jet and mist spray
- Shoulder strap for ease of transport
- Nozzle hook-up handle
- 1.2-m-long hose
- Not for use with hydrocarbons



1889N

018890220

~~938,00 €~~
384,00 €

Steel handling and storage base for 2 200-l barrels

- Easy to carry with a fork lift truck or a pallet jack
- Support cannot be placed under any part
- Completely hot painted with epoxy powder, for high resistance to chemicals
- Tank capacity: 235 l

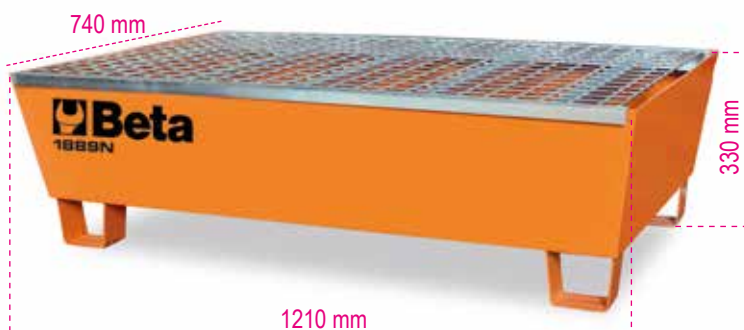

3027N



HYDRAULIC PRESS WITH MOVING PISTON

3027N 10

030270101

2.250,00 €

1.099,00 €

100 kg

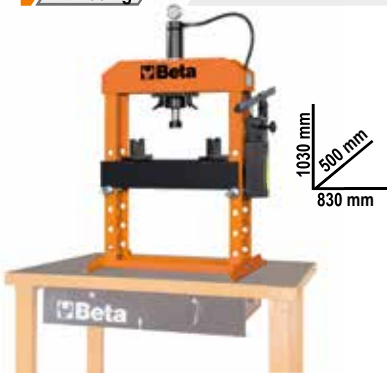

3027N 50

030270105

7.590,00 €

3.849,00 €

350 kg

2110 mm
760 mm
1350 mm



3027N 100

030270110

23.410,00 €

10.999,00 €

1100 kg

2400 mm
850 mm
1660 mm



380 V

3027N 20

030270102

3.110,00 €

1.429,00 €

130 kg

1870 mm
600 mm
920 mm



3027N 30

030270103

5.450,00 €

2.529,00 €

230 kg

2110 mm
600 mm
1140 mm



	3027N 10	3027N 20	3027N 30	3027N 50	3027N 100
Maximum capacity	10 t	20 t	30 t	50 t	100 t
Single speed pump	✓	✓	✓	✓	X
Moving piston	✓	✓	✓	✓	✓
Hydraulic safety in case of overloading	✓	✓	✓	✓	✓
Gauge	✓	✓	✓	✓	✓
Set of V-shaped prisms	✓	✓	✓	✓	✓
Hoist	X	X	✓	✓	✓

3025N 1,0

030250110

99 kg

2.550,00 €

1.276,00 €

Folding hydraulic crane with dual effect pump

- Maximum capacity: 1 t
- 4 loading positions: 300-600-800-1000 kg
- With load limiting valve and chrome-plated stand
- Controlled descent speed
- Nylon wheels
- Maximum height: 2420 mm

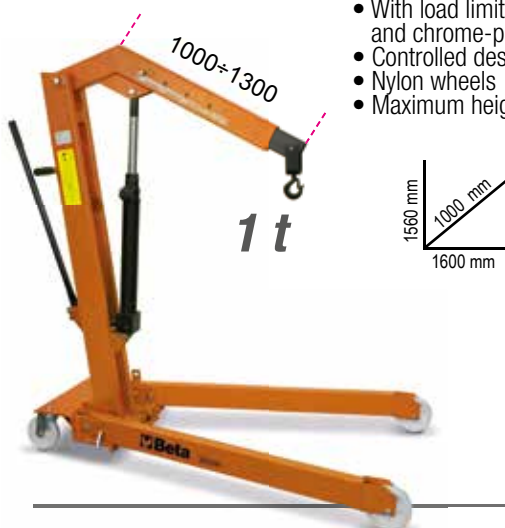

3025N/PF

030250111

557,00 €

318,00 €

Barrel handling pliers





8150

Lifting web slings, purple 1t
two layers with reinforced eyes
high-tenacity polyester (PES) belt
EN 1492-1

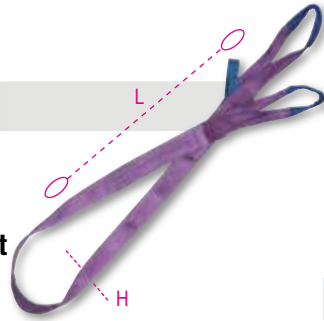

	L m	H mm		€
8150 1-T1	1	30	081500010	6,60 € 4,00 €
8150 2-T1	2	30	081500020	9,35 € 5,50 €
8150 3-T1	3	30	081500030	11,90 € 7,50 €
8150 4-T1	4	30	081500040	15,30 € 9,50 €

8153

Lifting web slings, green 2t
two layers with reinforced eyes
high-tenacity polyester
(PES) belt
EN 1492-1

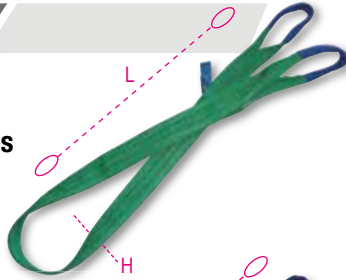

	L m	H mm		€
8153 1-T2	1	60	081530010	10,40 € 6,50 €
8153 2-T2	2	60	081530020	16,10 € 9,50 €
8153 3-T2	3	60	081530030	21,90 € 13,00 €
8153 4-T2	4	60	081530040	27,00 € 17,00 €

8156

Lifting web slings, yellow 3t
two layers with reinforced eyes
high-tenacity polyester
(PES) belt
EN 1492-1

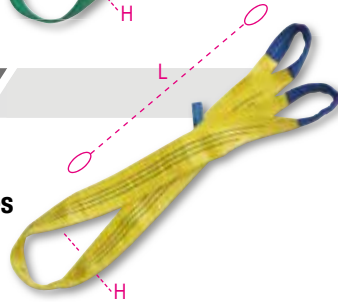

	L m	H mm		€
8156 2-T3	2	90	081560020	24,10 € 15,00 €
8156 3-T3	3	90	081560030	33,50 € 20,00 €
8156 4-T3	4	90	081560040	41,50 € 25,00 €
8156 6-T3	6	90	081560060	58,50 € 35,00 €

8181 6/B4

081810916

~~82,50 €~~
44,00 €

Bag with set of 4 ratchet tie-downs 8181,
6 m high-tenacity polyester belt (PES),
single hooks



8182 8,5/B2

081821885

~~72,50 €~~
38,00 €

Bag with set of 2 ratchet tie-downs 8182,
8.5 m high-tenacity polyester belt (PES)
single hooks



8091SL

lifting chain slings,
1 leg, self-locking hook,
grade 8

- Safety factor: 4
- Chain-sling identification tag
- Technical product specifications

EN 818-4

		L m	WLL t 0° $\leq 45^\circ$		€
8091SL D13-0,6	13	0,6	5,3	080910330	286,00 € 163,00 €
8091SL D16-0,6	16	0,6	8	080910360	578,00 € 329,00 €



NEW!

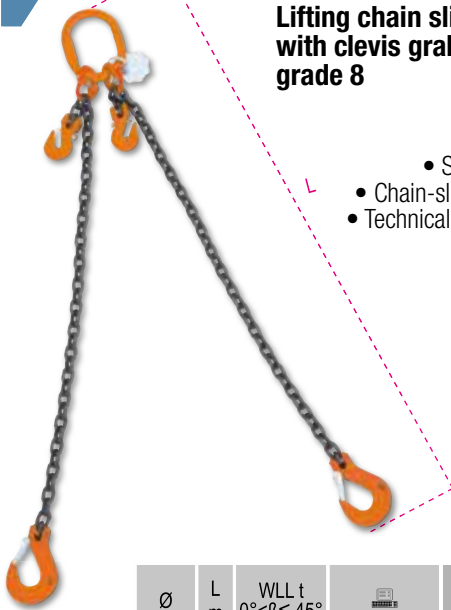

8097

Lifting chain sling, 2 legs with clevis grab hooks, grade 8

- Safety factor: 4
- Chain-sling identification tag
- Technical product specifications

EN 818-4

	∅	L	WLL t		€
	∞	m	0° < β ≤ 45°		
8097 D6-1	6	1	1,6	080970001	173,50 € 83,00 €
8097 D6-2	6	2	1,6	080970002	207,00 € 98,00 €
8097 D7-2	7	2	2,12	080970022	259,00 € 124,00 €
8097 D7-3	7	3	2,12	080970023	312,00 € 150,00 €
8097 D7-4	7	4	2,12	080970024	366,00 € 175,00 €
8097 D8-2	8	2	2,8	080970042	290,00 € 140,00 €
8097 D8-3	8	3	2,8	080970043	366,00 € 176,00 €
8097 D8-4	8	4	2,8	080970044	430,00 € 208,00 €
8097 D10-2	10	2	4,25	080970052	441,00 € 211,00 €
8097 D10-3	10	3	4,25	080970053	532,00 € 255,00 €
8097 D10-4	10	4	4,25	080970054	627,00 € 307,00 €

8098

Lifting chain sling, 4 legs with clevis grab hooks, grade 8

- Safety factor: 4
- Chain-sling identification tag
- Technical product specifications

EN 818-4

	∅	L	WLL t		€
	∞	m	0° < β ≤ 45°		
8098 D6-1	6	1	2,36	080980001	356,00 € 203,00 €
8098 D6-2	6	2	2,36	080980002	438,00 € 250,00 €
8098 D7-2	7	2	3,15	080980022	505,00 € 288,00 €
8098 D7-3	7	3	3,15	080980023	609,00 € 347,00 €
8098 D7-4	7	4	3,15	080980024	717,00 € 409,00 €
8098 D8-2	8	2	4,25	080980042	591,00 € 337,00 €
8098 D8-3	8	3	4,25	080980043	718,00 € 409,00 €
8098 D8-4	8	4	4,25	080980044	879,00 € 501,00 €

8097SL

Lifting chain slings, 2 legs, with self-locking and clevis grab hooks, grade 8

	∅	L	WLL t		€
	∞	m	0° < β ≤ 45°		
8097SL D6-1	6	1	1,6	080970201	213,50 € 122,00 €
8097SL D6-2	6	2	1,6	080970202	247,00 € 141,00 €
8097SL D7-2	7	2	2,12	080970222	314,00 € 151,00 €
8097SL D7-3	7	3	2,12	080970223	367,00 € 176,00 €
8097SL D7-4	7	4	2,12	080970224	421,00 € 204,00 €
8097SL D8-2	8	2	2,8	080970242	343,00 € 165,00 €
8097SL D8-3	8	3	2,8	080970243	419,00 € 201,00 €
8097SL D8-4	8	4	2,8	080970244	483,00 € 241,00 €
8097SL D10-2	10	2	4,25	080970252	517,00 € 249,00 €
8097SL D10-3	10	3	4,25	080970253	608,00 € 292,00 €
8097SL D10-4	10	4	4,25	080970254	703,00 € 351,00 €

8098SL

Lifting chain slings, 4 legs, with self-locking and clevis grab hooks, grade 8

	∅	L	WLL t		€
	∞	m	0° < β ≤ 45°		
8098SL D6-1	6	1	2,36	080980201	438,00 € 250,00 €
8098SL D6-2	6	2	2,36	080980202	536,00 € 305,00 €
8098SL D7-2	7	2	3,15	080980222	614,00 € 350,00 €
8098SL D7-3	7	3	3,15	080980223	718,00 € 409,00 €
8098SL D7-4	7	4	3,15	080980224	826,00 € 471,00 €
8098SL D8-2	8	2	4,25	080980242	696,00 € 397,00 €
8098SL D8-3	8	3	4,25	080980243	824,00 € 470,00 €
8098SL D8-4	8	4	4,25	080980244	985,00 € 561,00 €

8143 EN 13157 (CE) TÜV

Hand chain blocks

- Professional model, complies with EN13157 standard, made of first-rate materials
- Designed to lift heavy loads quickly and safely

	WLL t	L m	kg		€
8143 0,5T	0,5	3	9,2	081430005	232,50 € 140,00 €
8143 1T	1	3	11,7	081430010	274,00 € 164,00 €
8143 2T	2	3	19,5	081430020	398,00 € 239,00 €
8143 3T	3	3	19,5	081430030	514,00 € 296,00 €



8143SL EN 13157 (CE) **NEW!**

Hand chain blocks with self-locking hooks

	WLL t	L m	kg		€
8143SL 1,0	1,0	3	16	081430310	327,00 € 186,00 €
8143SL 2,0	2,0	3	26	081430320	431,00 € 246,00 €



8146 EN 13157 (CE) TÜV

Lever hoists

- Professional model, complies with EN13157 standard, easy to install and use
- Automatic brake with double pawl system for optimized safety
- Swivel hook with safety latch.

AVAILABLE CERTIFICATES

- CE Declaration of Conformity
- Test report UNI EN10204 type 2.2
- Manufacturer's Certificate

	WLL t	L m	kg		€
8146 0,75T	0,75	1,5	6,7	081460008	284,00 € 169,00 €
8146 1,5T	1,50	1,5	11,2	081460015	404,00 € 242,00 €



LIGHTWEIGHT AND PORTABLE

8146SL EN 13157 (CE) **NEW!**

Hand lever hoists with self-locking hooks

	WLL t	L m	kg		€
8146SL 0,75	0,75	1,5	7,5	081460308	358,00 € 204,00 €
8146SL 1,5	1,5	1,5	13,6	081460315	470,00 € 268,00 €



8146C (CE)

Lever hoist, compact

	WLL t	L m	kg		€
8146C 0,25T	0,25	1,5	2,5	081460002	261,00 € 156,00 €

8134

Permanent magnetic lifters

TECHNICAL DATA

- Safety factor: 3
- Identification tag

AVAILABLE CERTIFICATES

- Manufacturer's Certificate
- Declaration of Conformity with Machinery Directive 2006/42/EC
- Test Report UNI EN10204 type 2.2
- Operation and maintenance manual

	C mm	B mm		€
8134 100 kg	92	64	081340010	503,00 € 246,00 €
8134 300 kg	165	88	081340030	882,00 € 435,00 €
8134 600 kg	236	118	081340060	1.640,00 € 794,00 €
8134 1000 kg	264	168	081340100	2.710,00 € 1.286,00 €



Remove any protective films, dirt, grease, oil etc. between the magnet and the load.

8148

EN 13157



Manual rope winch, aluminium alloy body, complete with operating lever, rope and hook



L 20/30 m

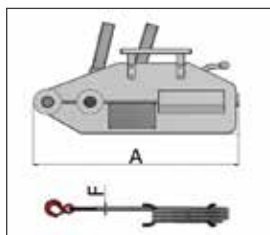

- Safety factor: 4:1
 - Identification plate with serial number and batch number
- AVAILABLE CERTIFICATES**
- CE Declaration of Conformity
 - Test report UNI EN10204 type 2.2
 - Manufacturer's Certificate

	WLL t	L m	A mm	ø f mm		€
8148 0,8X20M	0,8	20	426	8,3	081480008	418,00€ 248,00 €
8148 1,6X20M	1,6	20	545	11	081480016	654,00€ 385,00 €
8148 3,2X20M	3,2	20	660	16	081480032	1.076,00€ 644,00 €

8135

EN 13155



Steel plate lifting clamps with articulated lifting eyes

TECHNICAL DATA

- Safety factor: 3
- Serial number identification plate

AVAILABLE CERTIFICATES

- Manufacturer's Certificate
- CE Declaration of Conformity
- Test report UNI EN10204 type 2.2
- Technical product specifications

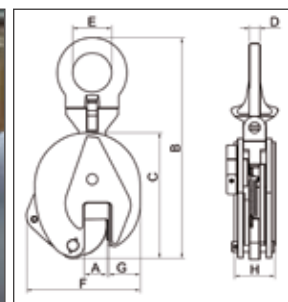

Do not lift any load weighing less than 10% of the maximum rated capacity.

	max WLL t	A mm	kg		€
8135 0,75T	0,75	0-15	2	081350005	144,00€ 86,00 €
8135 1,0T	1,0	0-20	5	081350010	194,50€ 117,00 €
8135 2,0T	2,0	0-25	8	081350020	289,00€ 173,00 €
8135 3,0T	3,0	0-30	15	081350032	491,00€ 294,00 €
8135 5,0T	5,0	0-50	23	081350050	690,00€ 414,00 €

max WLL (t)	Dimensions mm						
	B	C	D	E	F	G	H
0,75	205	125	10	27	105	35	40
1,0	290	170	12	48	145	45	56
2,0	375	205	17	67	175	56	56
3,0	425	237	20	75	215	60	78
5,0	480	262	20	80	232	65	90

8135H

EN 13155

Horizontal lifting clamps for flat surfaces, max. hardness 30HRC/300HB

TECHNICAL DATA

- Identification plate with serial number and batch number
- Safety factor: 3

AVAILABLE CERTIFICATES

- CE Declaration of Conformity
- Test report UNI EN10204 type 2.2
- Manufacturer's Certificate

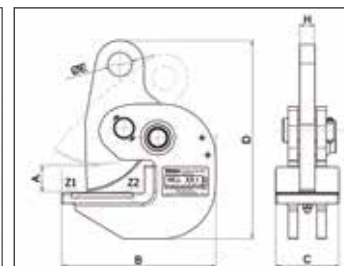

	max WLL t	A mm	kg		€
8135H 0,75T	0,75	25	2,5	081350307	137,50€ 74,00 €
8135H 1,5T	1,5	30	4,0	081350315	180,50€ 97,00 €
8135H 3,0T	3,0	45	6,0	081350330	266,00€ 143,00 €

max WLL (t)	Dimensions mm						
	B	C	D	Ø E	F	G	H
0,75	125	50	165	22	6	1x45°	14
1,5	158	65	205	25	6	1x45°	16
3,0	185	70	245	30	6	1x45°	18



THE REVOLUTIONARY IMPACT WRENCH

NEW!

THAT DOES NOT REQUIRE LUBRICATION

The impact wrench, 19270LS, fully designed, developed and engineered by Beta Utensili, relies on the OIL-LESS system, a brand-new innovation in the pneumatic tool industry: it allows the impact wrench to operate without having to be periodically lubricated with oil, thus ensuring increased durability and high performance.

The painstakingly studied assembly, micrometer alignment of the interior parts and use of innovative first-rate materials result in a reduced number of failures, for lubrication-free lifetime use.

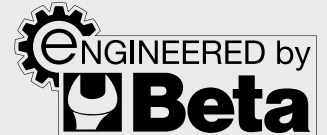

PATENT PENDING

The OIL-LESS impact wrench stands out for high TORQUE TRANSMISSION – that is, 1750 Nm –, which makes it ideal for any application.



19270LS

NEW!

019270010

803,00 €

439,00 €

2,5 Kg

OIL-LESS reversible impact wrench, body made from aluminium alloy

- No lubrication required
- Double hammer impulse device

Free speed	8.000 rpm
Max. torque	1.750 Nm
Bolt capacity	Cl 8.8 M24 ● 36 mm
Bolt capacity	Cl 12.9 M20 ● 30 mm
Air inlet	1/4" GAS
Operating pressure	6,2 bar
Internal hose size (Ø)	10 mm
Mean air consumption	198 l/min



4 TIMES THE USEFUL LIFE OF A CLASSIC IMPACT WRENCH



Based on these hallmarks, the OIL-LESS impact wrench can boast an excellent cost/benefit ratio, thus translating into savings in the long run.

1927P CE
 019270008 2 kg ~~495,00 €~~
219,00 €

12" Reversible impact wrench

- Double hammer impulse device
- Lightweight and well-balanced for enhanced ease of use
- Reversible lever
- Three power adjustable screwing positions
- Exhaust through handle
- Vibration-damping handle



Free speed	rpm	7.500
Impulse device		Double hammer
Max. torque	Nm	1750
Bolt capacity	Cl 8.8	M24●36 mm
Bolt capacity	Cl 12.9	M20●30 mm
Air inlet	GAS	1/4"
Operating pressure	bar	6,2
Internal hose size (Ø)	mm	10
Mean air consumption	l/min	290

1927P/K3 CE
 019270118 4 kg ~~647,00 €~~
241,00 €

12" Reversible impact wrench, supplied with 3 impact sockets, in plastic case



720LC
17-19-21 mm

1927XM CE
 019270030 1,3 kg ~~308,00 €~~
164,00 €

12" Compact reversible impact wrench

- Single hammer impulse device
- Amazingly compact and powerful
- One-hand reverse button
- Three power adjustable screwing positions
- Exhaust through handle
- Balancing hook



Free speed	rpm	10.000
Impulse device		Single hammer
Max. torque	Nm	770
Bolt capacity	Cl 8.8	M22●34 mm
Bolt capacity	Cl 12.9	M18●27 mm
Air inlet	GAS	1/4"
Operating pressure	bar	6,2
Internal hose size (Ø)	mm	10
Mean air consumption	l/min	122

1927XM/K5 CE
 019270129 2,8 kg ~~380,00 €~~
197,00 €

12" Assortment of 1 compact reversible impact wrench and 5 impact sockets, in plastic case



720 17-19-21-22-24 mm



1927E
 019270005 2,4 kg
~~154,00 €~~
87,00 € **NEW!**

12" Reversible impact wrench, made from composite material



- Double hammer impulse device
- Reverse control knob
- Three power adjustable screwing positions
- Exhaust through handle
- Vibration-damping handle

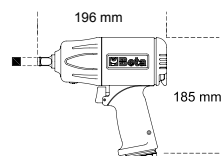

Free speed	rpm	7.000
Impulse device		Double hammer
Max. torque	Nm	750
Bolt capacity	Cl 8.8	M22●36 mm
Bolt capacity	Cl 12.9	M18●30 mm
Air inlet	GAS	1/4"
Operating pressure	bar	6,2
Internal hose size (Ø)	mm	10
Mean air consumption	l/min	140

1927C
 019270006 2,4 kg
~~259,00 €~~
142,00 € **NEW!**

12" Reversible impact wrench, made from composite material



- Double hammer impulse device
- Lightweight and well-balanced, for enhanced ease of use
- Reverse control lever
- Three power adjustable screwing positions
- Exhaust through handle
- Vibration-damping handle

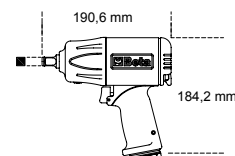

Free speed	rpm	9.000
Impulse device		Double hammer
Max. torque	Nm	950
Bolt capacity	Cl 8.8	M22●34 mm
Bolt capacity	Cl 12.9	M18●27 mm
Air inlet	GAS	1/4"
Operating pressure	bar	6,2
Internal hose size (Ø)	mm	10
Mean air consumption	l/min	125

1928XM
 019280030 1,3 kg
~~658,00 €~~
373,00 €



3/4" Compact reversible impact wrench

- Double hammer impulse device
- Amazingly compact and powerful
- One-hand reverse button
- Three power adjustable screwing positions
- Exhaust through handle



ULTRA COMPACT AND POWERFUL

1600 Nm

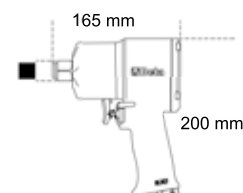

Free speed	rpm	4.800
Impulse device		Double hammer
Max. torque	Nm	1600
Bolt capacity	Cl 8.8	M27●41 mm
Bolt capacity	Cl 12.9	M24●36 mm
Air inlet	GAS	3/8"
Operating pressure	bar	6,2
Internal hose size (Ø)	mm	10
Mean air consumption	l/min	175



1928P

019280006 3,7 kg



1.318,00 €
604,00 €

3/4" Reversible impact wrench, made from composite material

- Double hammer impulse device
- Lightweight and well-balanced for enhanced ease of use
- Reversible lever
- Three power adjustable screwing positions
- Exhaust through handle
- Vibration-damping handle



2100 Nm
ULTRA COMPACT AND POWERFUL

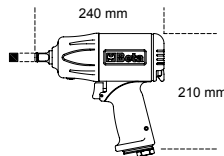

Free speed	rpm	5.000
Impulse device		Double hammer
Max. torque	Nm	2100
Bolt capacity	Cl 8.8	M30●46 mm
Bolt capacity	Cl 12.9	M27●41 mm
Air inlet	GAS	3/8"
Operating pressure	bar	6,2
Internal hose size (Ø)	mm	10
Mean air consumption	l/min	221

1930PA

019300032 9,6 kg



1.428,00 €
769,00 €

1" Reversible impact wrench

- Double hammer impulse device
- Auxiliary handle
- Reversible lever
- Three power adjustable screwing/unscrewing positions
- Exhaust through handle

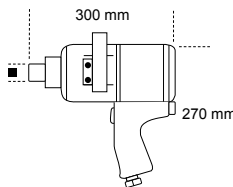

Free speed	rpm	3.500
Impulse device		Double hammer
Max. torque	Nm	2445
Bolt capacity	Cl 8.8	M36●55mm
Bolt capacity	Cl 12.9	M30●46mm
Air inlet	GAS	1/2"
Operating pressure	bar	6,2
Internal hose size (Ø)	mm	13
Mean air consumption	l/min	350

1922P3

019220013 1,5 kg



481,00 €
274,00 €

1/2" Reversible air impact ratchets

- Double rocking dog" impulse device
- Easy tightening: The impact mechanism system eliminates wrist twisting at end of screwing and shortens operating time
- Compact and powerful: maximum torque is significantly higher than maximum torque as achieved with a conventional ratchet
- Ergonomic rubber handle



292 mm

136 Nm
HIGH TORQUE WITHOUT AFFECTING WRIST

Free speed	rpm	600
Maximum torque	Nm	136
Bolt capacity	Cl 8.8	M12●18 mm
Bolt capacity	Cl 12.9	M10●16 mm
Air inlet	GAS	1/4"
Operating pressure	bar	6,2
Internal hose size (Ø)	mm	10
Mean air consumption	l/min	113

720ME/C8
007200525 ~~170,00 €~~
98,00 €



Set of 8 impact socket drivers for hexagon screws, in metal case



○ 5-6-8-10-12-14-17-19 mm



≡ 270x120x45 mm

720LC/C3
007200653 ~~44,00 €~~
26,00 €



Set of 3 impact sockets for wheel nuts, with polymeric inserts

○ 17-19-21 mm



≡ 148x132x44 mm

720/C12
007200912 ~~217,50 €~~
120,00 €



Set of 12 impact sockets

○ 10-11-12-13-14-17-19-22-24-27-30-32 mm



≡ 195x80x55 mm

1933IH
019330006 ~~246,50 €~~
142,00 €



High-power die grinder

- Collect chuck, Ø 3 mm and 6 mm

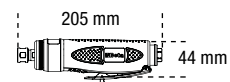

Free speed	rpm	20.000
Chuck capacity	mm	3-6
Power	kW	0,75
Air inlet	GAS	1/4"
Operating pressure	bar	6,2
Internal hose size (Ø)	mm	10
Mean air consumption	l/min	370

1933
019330001 ~~161,50 €~~
91,00 €



Die grinder

- Collect chuck, Ø 3 mm and 6 mm



Free speed	rpm	25.000
Chuck capacity	mm	3-6
Power	kW	0,20
Air inlet	GAS	1/4"
Operating pressure	bar	6,2
Internal hose size (Ø)	mm	10
Mean air consumption	l/min	230

1942A
019420000 ~~372,00 €~~
211,00 €



Air saw

- Powerful and handy
- Designed for cutting bodies, exhaust pipes and silencers, aluminium and plastic
- Complete with rubber handle, PVC exhaust pipe and air-feeding hose
- Rear exhaust

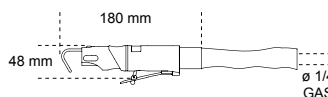

Strokes per minute		10.000
Stroke length	mm	10
Air inlet	GAS	1/4"
Operating pressure	bar	6,2
Internal hose size (Ø)	mm	8
Mean air consumption	l/min	75

1936/5A

019360025 1,9 kg



501,00 €
283,00 €

Angle grinder

- Extremely compact and handy
- Air governor for automatically controlling top speed
- Right-hand/left-hand auxiliary handle
- Spindle lock button
- Accessory for quickly changing discs
- Safety cap can be quickly adjusted in nine different positions through quick release
- Rear exhaust



Ø 125 mm

Free speed	rpm	10.000
Power	mm	125
Spindle thread	Cl 8.8	0,66
Air inlet	Cl 12.9	14
Operating pressure	GAS	1/4"
Internal hose size (Ø)	bar	6,2
Mean air consumption	mm	10
Consumo aria medio	l/min	390

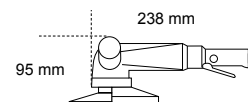

1946

019460001



226,50 €
131,00 €

Air riveter

- Supplied with interchangeable nozzles, 2.4 -3.2 – 4.0 – 4.8 mm long, a safety nail container and a balancing hook

Material/Riveter	2,4	3,2	4	4,8
Copper	✓	✓	✓	✓
Aluminium	✓	✓	✓	✓
Steel	✓	✓	✓	✓
Stainless steel	✓	✓	✓	✓

Trekkracht	8.000 N
Slaglengthe	14 mm
Max.nagelcapaciteit	Ø Werkdruk 4,8 mm
Luchtinlaat	1/4" GAS
Werkdruk	6,2 bar
Luchtslang binnen	6 mm
Luchtverbruik	1,2 l/cycle

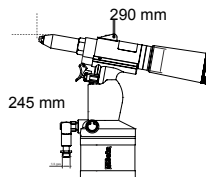

1946C 7,8

019460008



1.113,00 €
549,00 €

Automatic air suction riveter

- Professional air riveter for use with 2.4 - 3.2 - 4.0 - 4.8 mm long steel, stainless steel, aluminium and copper rivets
- Pointed cone-shaped spout
- Powerful and handy, with handle made of composite material
- Complete with safety nail container and oil gun

Material/Riveter	2,4	3,2	4	4,8
Copper	✓	✓	✓	✓
Aluminium	✓	✓	✓	✓
Steel	✓	✓	✓	✓
Stainless steel	✓	✓	✓	✓

Traction power	16.900 N
Stroke length	22,5 mm
Maximum rivet capacity	Ø stainless steel 7,8 mm
Air inlet	1/4" GAS
Operating pressure	6,2 bar
Internal hose size (Ø)	10 mm
Air consumption	4,9 l/cycle

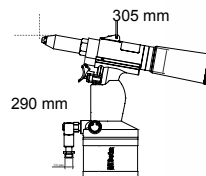

1949XS

019490025



7,85 €
4,50 €

Progressive blow pen

- Made from light alloy
- Air flow can be adjusted by rotating head



Threaded brass insert	1/4"
Operating pressure	3-8 bar
Maximum operating pressure	10 bar
Operating temperature	-20°C + 70°C

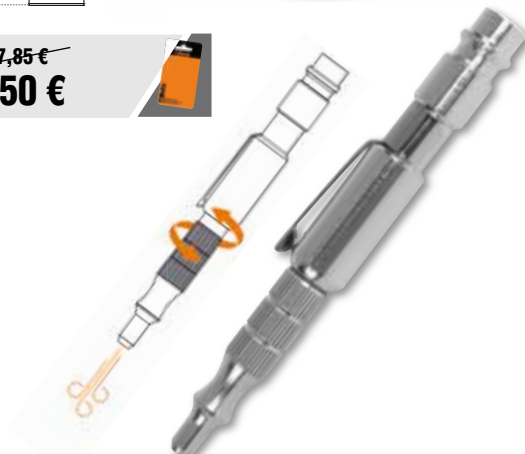



**SAFETY FOOTWEAR AND WORKWEAR
SPRING/SUMMER COLLECTION**



**20
25**

EU	35	36	37	38	39	40	41	42	43	44	45	46	47	47
UK	2,5	3,5	4,5	5	6	6,5	7	8	9	10	10,5	11	12	13

RENEGADE

NEW!

THE NEW SAFETY FOOTWEAR RANGE

Renegade, has been designed to provide uncompromising safety and style.

The range, which comprises 6 models in unique colours and materials, perfectly suits those interested in standing out in any working environment. Renegade relies on a design inspired by latest generation sports shoes, superior cushioning and remarkable support to provide comfort all day long.



INNOVATIVE DESIGN

HIGHLY BREATHABLE

EVA OUTSOLE WITH DURABLE NITRILE RUBBER TREAD WIDE FIT

THE WIDE BODY
The wide body – 11 – ensures smooth, comfortable walks, without compressing the foot.

QUICK LACING SYSTEM
Model 7340VA is Beta's eerste schoen die is uitgerust met een snelsluitsysteem.

BASED ON A BOLD, UNCONVENTIONAL STYLE,
Renegade is an ideal pick for modern professionals.

METAL FREE
composite fibre penetration-proof insole



7340VA ~~188,00 €~~
107,00 €

RENEGADE mesh fabric shoe, highly breathable, with ATOP lacing

S1PS FO SR HRO

Sizes available: from 37 to 48
from 073400537 to 073400548

RENEGADE

NEW!
7340G
~~153,00 €~~
87,00 €

RENEGADE mesh fabric shoe, highly breathable, with traditional lacing

Sizes available: from 37 to 48

 da 073400**637** a 073400**648**
S1PS FO SR HRO
7341V
~~160,50 €~~
89,50 €

RENEGADE woven fabric, hard-wearing and breathable, green details

Sizes available: from 37 to 48

 da 073410**537** a 073410**548**
S1PS FO SR HRO
7341Y
~~160,50 €~~
89,50 €

RENEGADE woven fabric shoe, hard-wearing and breathable, yellow details

Sizes available: from 37 to 48

 da 073410**637** a 073410**648**
S1PS FO SR HRO
7342N
~~170,50 €~~
97,00 €

RENEGADE microfibre shoe, water-repellent

Sizes available: from 37 to 48

 da 073420**537** a 073420**548**
S3S FO SR HRO
7343N

RENEGADE microfibre ankle shoe, water-repellent

~~186,00 €~~
105,00 €
Sizes available: from 37 to 48

 da 073430**537** a 073430**548**
S3S FO SR HRO

FitEvolution

Seven uniquely designed models, available in several colours and materials, ranging from mesh to microfibre, to satisfy the most demanding users' requirements.

THE PATENTED SYSTEM BETA FIT4YOU

After several years of painstaking studying and designing, we developed the patented system, **FIT 4 YOU**. This state-of-the-art penetration-proof insole pressing process allows three different **ETPU** inserts – each with different densities – to be combined, to provide three levels of comfort, thus satisfying every user's requirements.

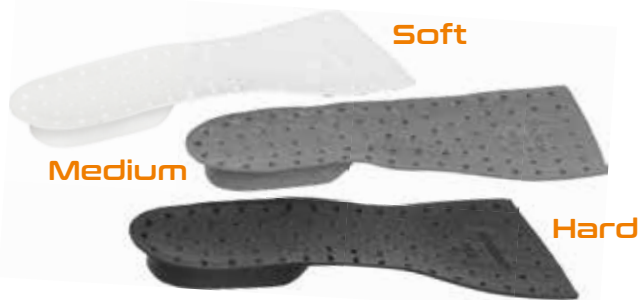

ETPU Inserts

ETPU is the core of the FIT 4 YOU system, ensuring a cushioning effect and energy return. Based on three provided inserts varying in density and colour, it allows both softness and support to be customized in the shoe, according to weight, height and personal requirements. This groundbreaking technology ensures optimal comfort while moving as well as during static breaks, thereby resulting in reduced joint stress and fatigue



The patented system, **FIT 4 YOU**, is based on **3 provided ETPU** inserts, varying in density and colour, to allow the user to customize the shoe according to weight, height and personal usage requirements.



- Composite toe cap
- Composite fibre penetration-proof insole
- 3 ETPU inserts, with 3 different densities, for a customized shoe
- Heel stability support and traditional lacing.
 - Dual-density polyurethane outsole

7272V

163,00 €
92,00 €

FitEvolution woven fabric shoe,
hard-wearing and highly breathable

S1 PS FO SR ESD



Sizes available: from 37 to 48
da 072720137 a 072720148

7270Y
~~163,00 €~~
92,00 €

FitEvolution mesh fabric shoe, highly breathable

**S1 PS FO SR ESD**
 Sizes available: from 37 to 48
 da 072700137 a 072700148
7271V
~~163,00 €~~
92,00 €

FitEvolution suede shoe, perforated

**S1 PS FO SR ESD**
 Sizes available: from 37 to 48
 da 072710137 a 072710148
7273G
~~167,00 €~~
95,00 €

FitEvolution nubuck shoe, water-repellent

**S3 S FO SR ESD**
 Sizes available: from 37 to 48
 da 072730137 a 072730148
7274G
~~172,50 €~~
98,00 €

FitEvolution nubuck ankle shoe, water-repellent

**S3 S FO SR ESD**
 Sizes available: from 37 to 48
 da 072740237 a 072740248
7275N
~~167,00 €~~
95,00 €

FitEvolution microfibre shoe, water-repellent

**S3 S FO SR ESD**
 Sizes available: from 37 to 48
 da 072750237 a 072750248
7276N
~~172,50 €~~
98,00 €

FitEvolution microfibre ankle shoe, water-repellent

**S3 S FO SR ESD**
 Sizes available: from 37 to 48
 da 072760237 a 072760248

Beta
O-Gravity



- EVA outsole with durable nitrile rubber tread
- Heel stability support
- Composite fibre penetration-proof insole

EXTREMELY LIGHT

APPROXIMATE WEIGHT FOR SIZE 42

LESS THAN 500 g

7352B

450 g

~~145,00 €~~
82,00 €

O-Gravity mesh fabric shoe, highly breathable, with TPU inserts

- Composite toe cap
- Stretch slip-on collar



S1P HRO SRC

ESSENTIAL

Sizes available: from 38 to 48
da 073520138 a 073520148

7352G

450 g

~~150,00 €~~
85,00 €

O-Gravity mesh fabric shoe, waterproof, with TPU inserts

- Composite toe cap
- Traditional lacing
- Wide fit



S1P HRO SRC ESD

ESSENTIAL



Sizes available: from 38 to 48
da 073520338 a 073520348

7354N

460 g

~~149,50 €~~
85,00 €

Mesh fabric shoe, waterproof, with TPU inserts

- Composite toe cap
- Stretch slip-on collar



S3 HRO SRC

ESSENTIAL

Sizes available: from 38 to 48
da 073540038 a 073540048

7356G

460 g

~~154,50 €~~
87,00 €

O-Gravity shoe, ultralightweight, made of water-repellent microfibre

- Composite toe cap
- Stretch slip-on collar



S3 HRO SRC

ESSENTIAL

Sizes available: from 38 to 48
da 073560038 a 073560048

7372B

450 g

~~153,50 €~~
86,00 €

O-Gravity mesh fabric shoe, highly breathable, with TPU inserts

- Composite toe cap
- Stretch slip-on collar



S1P HRO SRC

NUBES

Sizes available: from 38 to 48
da 073720038 a 073720048

ACTIVE



EN ISO
20345
2011



- Composite toe cap
- Composite fibre penetration-proof insole

7316NB

~~97,00 €~~
54,50 €

Mesh and suede shoe, highly breathable,
with heel stability support



S1P SRC ESD



Sizes available: from 35 to 48
da 073160735 a 073160748

7316NG

~~97,00 €~~
54,50 €

Mesh and suede shoe, highly breathable,
with heel stability support



S1P SRC ESD



Sizes available: from 35 to 48
da 073160635 a 073160648

7320NA

~~87,50 €~~
49,00 €

Nubuck shoe, water-repellent,
with anti-abrasion reinforcement in toe cap area



S3 SRC

Sizes available: from 35 to 48
da 073200535 a 073200548

7321NA

~~90,00 €~~
52,00 €

Nubuck shoe, water-repellent, with quick opening system
and antiabrasion reinforcement in toe cap area



**QUICK
OPENING
SYSTEM**

S3 SRC RS

Sizes available: from 35 to 48
da 073210535 a 073210548

7322SA

~~94,50 €~~
54,00 €

Fabric shoe, highly resistant to abrasion



S3 SRC

Sizes available: from 35 to 48
da 073220435 a 073220448

7317NA

~~83,00 €~~
48,00 €

Suede shoe, perforated,
with microfibre reinforcement in heel area



S1P SRC

Sizes available: from 35 to 48
da 073170135 a 073170148

FLEX



- Composite toe cap
- Composite fibre penetration-proof insole

THE MOST FLEXIBLE

7212B

490 g

~~81,50 €~~
43,00 €

Suede shoe, perforated, with mesh inserts.
Anti-abrasion insert in toe cap area



S1P SRC ESD



Sizes available: from 35 to 48
da 072120235 a 072120248

7212G

490 g

~~81,50 €~~
43,00 €

Suede shoe, perforated.
With anti-abrasion insert in toe cap area.



S1P SRC ESD



Sizes available: from 35 to 48
da 072120335 a 072120348

7213G

490 g

~~81,50 €~~
43,00 €

Suede shoe, perforated,
with highly breathable mesh inserts



S1P SRC ESD



Sizes available: from 35 to 48
da 072130135 a 072130148

7214G

500 g

~~88,00 €~~
47,00 €

Action nubuck shoe, water-repellent,
with anti-abrasion insert in toe cap area



S3 SRC ESD



Sizes available: from 35 to 48
da 072140235 a 072140248

7218G

550 g

~~92,00 €~~
49,00 €

Water-repellent action
nubuck ankle shoe



**QUICK
OPENING
SYSTEM**

S3 SRC RS ESD



Sizes available: from 35 to 48
da 072180135 a 072180148

BASIC

EN ISO
20345
2022



NEW!

- Steel toe cap
- Steel penetration-proof insole

7241NC

~~50,00 €~~
28,00 €

Leather safety shoe, water-repellent



S3 FO SR

Sizes available: from 35 to 48
da 072411635 a 072411648

NEW LOOK!

7243NC

~~51,50 €~~
30,00 €

Leather ankle shoe, water-repellent,
with quick opening system



S3 FO SR RS

Sizes available: from 35 to 48
da 072431635 a 072431648

7246NB

~~48,50 €~~
27,00 €

Suede shoe, perforated



S1P FO SR

Sizes available: from 35 to 48
da 072461635 a 072461648

7248NB

~~51,50 €~~
29,00 €

Suede ankle shoe



**QUICK
OPENING
SYSTEM**

S1P FO SR RS

Sizes available: from 35 to 48
da 072481635 a 072481648

7245NB

~~56,00 €~~
32,00 €

Leather ankle shoe, water-repellent,
with quick opening system and front
protection with strap closure



S3 FO SR RS

Sizes available: from 35 to 48
da 072451635 a 072451648

**QUICK OPENING
SYSTEM**



7982N ~~10,90 €~~
 6,50 €
 079820000

Curved visor
 Cap, 100% polyester, strap closure black



7643G NEW! ~~53,50 €~~
 29,80 €

Sweatshirt
 • Short-zipped, 80% cotton, 20% polyester, 280 g/m², anthracite/light grey



XS	S	M	L	XL	2XL	3XL
076430000	076430001	076430002	076430003	076430004	076430005	076430006

7820SG NEW! ~~68,00 €~~
 39,00 €

Stretch work trousers, multipocket style
 • 39% cotton, 61% polyester,
 • Mechanical stretch ripstop fabric, 170 g/m²
 • GreyKnee
 • Pad pockets and stretch waistband on sides
 • Regular fit



XS 46	S 48	M 50	L 52	XL 54	2XL 56	3XL 58
078200100	078200101	078200102	078200103	078200104	078200105	078200106

7821SG NEW! ~~53,50 €~~
 29,80 €

Stretch work Bermuda shorts, multipocket style
 • 39% cotton, 61% polyester,
 • Mechanical stretch ripstop fabric, 170 g/m²
 • GreyKnee
 • Pad pockets and stretch waistband on sides
 • Regular fit



7340VA NEW!
 Renegade 80

XS 46	S 48	M 50	L 52	XL 54	2XL 56	3XL 58
078210100	078210101	078210102	078210103	078210104	078210105	078210106

7669N

~~116,50 €~~
54,50 €

Stretch work jacket, lightweight, multipocket style

- 86% nylon, 14% spandex, 140 gm², black
- With detachable sleeves and retractable hood.
- Water-resistant, wind-stopping



	XS	S	M	L	XL	2XL	3XL
	076690000	076690001	076690002	076690003	076690004	076690005	076690006

7664N

~~58,00 €~~
31,00 €

Sweatshirt, long-zipped

- 280 g/m², black
- 60% cotton, 40% polyester



	XS	S	M	L	XL	2XL	3XL
	076640000	076640001	076640002	076640003	076640004	076640005	076640006

7660

~~88,50 €~~
48,00 €

Stretch work trousers, lightweight, multipocket style

- 86% nylon - 14% spandex, 140 g/m², anthracite grey
- Knee pad pockets, rear pockets reinforced in polyester 300D, tearproof crotch
- Slim fit



SLIM FIT

	XS 46	S 48	M 50	L 52	XL 54	2XL 56	3XL 58
7660G	076600000	076600001	076600002	076600003	076600004	076600005	076600006
7660B	076600100	076600101	076600102	076600103	076600104	076600105	076600106

7661

~~77,00 €~~
42,00 €

Stretch work Bermuda shorts, lightweight, multipocket style

- 86% nylon - 14% spandex, 140 g/m², anthracite grey



SLIM FIT

	XS 46	S 48	M 50	L 52	XL 54	2XL 56	3XL 58
7661G	076610000	076610001	076610002	076610003	076610004	076610005	076610006
7661B	076610100	076610101	076610102	076610103	076610104	076610105	076610106

7275N

FitEvolution 83



7552

~~20,40 €~~
11,00 €

NEW!

Technical polo shirt,
Ho-Cooling® 190 g/m²
three-button



7552BL
Blue

7552G
Melange grey

7552N
Black

100% COTTON

	XS	S	M	L	XL	2XL	3XL
7552BL	075520300	075520301	075520302	075520303	075520304	075520305	075520306
7552G	075520400	075520401	075520402	075520403	075520404	075520405	075520406
7552N	075520500	075520501	075520502	075520503	075520504	075520505	075520506

7553

~~13,80 €~~
7,50 €

NEW!

Work t-shirt made from jersey cotton, 150 g/m²



7553G
Melange grey

7553V
Sage green



7553BL
Blue

7553N
Black

100% COTTON

	XS	S	M	L	XL	2XL	3XL
7553BL	075530300	075530301	075530302	075530303	075530304	075530305	075530306
7553G	075530400	075530401	075530402	075530403	075530404	075530405	075530406
7553N	075530500	075530501	075530502	075530503	075530504	075530505	075530506
7553V	075530600	075530601	075530602	075530603	075530604	075530605	075530606

7548M

~~27,50 €~~
15,80 €

Modern print t-shirt, 100% cotton,
150 g/m²



	XS	S	M	L	XL	2XL	3XL
	075480400	075480401	075480402	075480403	075480404	075480405	075480406

7548C

~~27,50 €~~
15,80 €

Classic print t-shirt, 100% cotton,
150 g/m²



	XS	S	M	L	XL	2XL	3XL
	075480500	075480501	075480502	075480503	075480504	075480505	075480506



7212B
Flex 86

7550

~~44,50 €~~
25,00 €

Technical work t-shirt, made from polyester, 120 g/m²,
with 37.5® technology

- Grey with black, orange and reflex details



	XS	S	M	L	XL	2XL	3XL
7550G	075500400	075500401	075500402	075500403	075500404	075500405	075500406
7550N	075500500	075500501	075500502	075500503	075500504	075500505	075500506

PATENTED 37.5®
HYPOALLERGENIC, SKIN-FRIENDLY TECHNOLOGY.



7867

~~54,00 €~~
29,00 €



Sleeveless work jacket,
lightweight, in T/C twill, 180 g/m²

- 65% polyester, 35% cotton, 180 g/m² **Beta EASY**

LIGHT



	XS	S	M	L	XL	2XL	3XL	4XL	5XL
7867B	078670700	078670701	078670702	078670703	078670704	078670705	078670706	078670707	078670708
7867G	078670800	078670801	078670802	078670803	078670804	078670805	078670806	078670807	078670808

7553N **NEW!** Work t-shirt work, made from jersey cotton, 150 g/m²

7860

~~58,50 €~~
32,00 €



Work trousers in T/C twill, 180 g/m² **Beta EASY** LIGHT

- T/C twill, 65% polyester, 35% cotton; 180 g/m²
- T/C ripstop insets and knee pads
- Strap "Oxford" snap loop



7861

~~48,50 €~~
27,00 €



Work bermuda shorts, lightweight

- Made from T/C twill, 180 g/m², with Oxford inserts

Beta EASY LIGHT



	XS 46	S 48	M 50	L 52	XL 54	2XL 56	3XL 58	4XL 60	5XL 62
7860B	078600700	078600701	078600702	078600703	078600704	078600705	078600706	078600707	078600708
7860G	078600800	078600801	078600802	078600803	078600804	078600805	078600806	078600807	078600808
7861B	078610700	078610701	078610702	078610703	078610704	078610705	078610706	078610707	078610708
7861G	078610800	078610801	078610802	078610803	078610804	078610805	078610806	078610807	078610808

7865

~~93,00 €~~
52,00 €



Work overalls, lightweight

- 65% polyester, 35% cotton
- Oxford inserts

Beta EASY LIGHT



	XS 46	S 48	M 50	L 52	XL 54	2XL 56	3XL 58	4XL 60	5XL 62
7865B	078650700	078650701	078650702	078650703	078650704	078650705	078650706	078650707	078650708
7865G	078650800	078650801	078650802	078650803	078650804	078650805	078650806	078650807	078650808

7246NB **NEW!**

Basic

7642G

~~35,00 €~~
20,00 €



Crew-neck sweatshirt

- 60% cotton, 40% polyester, 240 g/m²

	XS	S	M	L	XL	2XL	3XL
	076420000	076420001	076420002	076420003	076420004	076420005	076420006

7984G

079840525

~~18,90 €~~
11,00 €



Work belt, 100% TPE, with chrome-plated zinc metal buckle

One size fits all; length: 125 cm, can be shortened; width: 35 mm, black

7610

~~79,00 €~~
45,00 €



SLIM FIT

“Work trekking” trousers, LIGHT

- 90% nylon, 10% stretch fabric, 140 g/m²
- Reinforced fabric on knees and back, stretch leg bottoms and drawstring
- Dark grey with yellow details
- Slim fit

TREKKING LIGHT

	XS 46	S 48	M 50	L 52	XL 54	2XL 56	3XL 58
7610G	076100000	076100001	076100002	076100003	076100004	076100005	076100006
7610N	076100100	076100101	076100102	076100103	076100104	076100105	076100106

7611G

~~60,50 €~~
35,00 €



SLIM FIT

“Work trekking” Bermuda shorts, LIGHT

- 90% nylon, 10% stretch fabric, 140 g/m²
- Reinforced fabric on back.
- Dark grey with yellow details

TREKKING LIGHT

	XS 46	S 48	M 50	L 52	XL 54	2XL 56	3XL 58
	076110000	076110001	076110002	076110003	076110004	076110005	076110006



7270Y
FitEvolution 83



7937MG

~~61,00 €~~
33,00 €



Sleeveless work jacket

- Front zip closure, flap-covered with strap closure
- Anti-abrasion inserts made from "Oxford" polyester/PU, 220 g/m²
- Chest pockets with strap closure and pen pocket
- Large waist pockets with strap closure
- Adjustable waistband with strap



Cotton



	XS	S	M	L	XL	2XL	3XL
	079370400	079370401	079370402	079370403	079370404	079370405	079370406

7553N

NEW!

Werk t-shirt, gemaakt van jersey katoen, 150 g/m²



7930MG

~~65,50 €~~
36,00 €



Work trousers, multipocket style

- 97% cotton, 3% stretch fabric, 220 g/m²
- Stretch waistband

Cotton



	XS 46	S 48	M 50	L 52	XL 54	2XL 56	3XL 58
	079300400	079300401	079300402	079300403	079300404	079300405	079300406

7931MG

~~53,00 €~~
29,00 €



Work bermuda shorts

- 97% cotton, 3% stretch fabric, 220 g/m²
- Stretch waistband



Cotton



	XS 46	S 48	M 50	L 52	XL 54	2XL 56	3XL 58
	079310400	079310401	079310402	079310403	079310404	079310405	079310406

7935MG

~~115,00 €~~
65,00 €



Work overalls

- 97% cotton, 3% stretch fabric, 220 g/m²
- Front closure with double tap zipper slider
- Collar with strap closure
- Cuffs with strap adjusters
- Knee pad inserts with strap closure



Cotton



	XS 46	S 48	M 50	L 52	XL 54	2XL 56	3XL 58
	079350400	079350401	079350402	079350403	079350404	079350405	079350406

7340G

NEW!

Renegade



7830SN

~~70,50 €~~
38,00 €

Stretch work trousers

- in T/C twill, 200 g/m², black

SLIM FIT



	XS 46	S 48	M 50	L 52	XL 54	2XL 56	3XL 58
	078300100	078300101	078300102	078300103	078300104	078300105	078300106

7850G

~~51,00 €~~
28,00 €

Cargo work trousers

- 100% cotton, 240 g/m²
- Stretch waistband on sides and large side pockets with reflex inserts
- Grey with fluorescent green details

SLIM FIT



	XS 46	S 48	M 50	L 52	XL 54	2XL 56	3XL 58	4XL 60
	078500100	078500101	078500102	078500103	078500104	078500105	078500106	078500107

7527

~~60,50 €~~
33,00 €

Work jeans

- 70% cotton, 27% polyester and 3% stretch fabric

Jeans

	XS	S	M	L	XL	2XL	3XL
	075270046	075270048	075270050	075270052	075270054	075270056	075270058



7529

~~53,00 €~~
28,00 €

Stretch work jeans bermuda shorts

- 98% cotton, 2% stretch fabric

Jeans

	XS	S	M	L	XL	2XL	3XL
	075290046	075290048	075290050	075290052	075290054	075290056	075290058



7317NA
Active 85

9563G

095630050

~~286,00 €~~
143,00 €

Office armchairs, for guests

- Back height: 60 cm
- Seat dimensions: 45 cm x 51 cm
- Overall chair height: 110-120 cm
- Base: 28 cm (leg length) x 50-60 cm (height)



9563U

095630020

~~594,00 €~~
274,00 €

Office armchair, ergonomic

- Back height: 97 cm
- Seat dimensions: 50 cm x 53 cm
- Overall chair height: 133-144 cm
- Base: 35 cm (leg length) x 49 cm (height)



9592MG/3

095920103

~~27,50 €~~
15,00 €

NEW!

Case with three black full graphite pencils



9527T

NEW!

095270030

~~22,00 €~~
12,00 €

Black ceramic cup with lasered BETA logo



9523T

095230050

~~24,00 €~~
14,00 €

Thermal bottle, made of stainless steel, 500 ml, double-layer technology, no air between walls, leak-proof cap, orange

- keeps cold drinks cold for 24 hours
- keeps hot drinks hot for 12 hours



9528C

NEW!

095280100

~~32,50 €~~
17,00 €

Football, PU-coated, size 5

- circumference: 68-70 cm
- panels: 12
- weight: 410-430 g
- recommended pressure: 6-8 lbs/ 0.41-0.55 bar/ 6-8 psi



9544C

095440101

~~169,00 €~~
87,00 €

Cabin-size trolley with 4 double wheels, TSA lock, USB port + 3.5-mm jack

40x20x55 mm



9525TR

095250011

~~27,50 €~~
13,00 €

Trucker cap with curved visor

- 50% cotton, 50% polyester, rear mesh, snapback style, black



9574

~~43,50 €~~
21,00 €



Work gloves



	M	L	XL	2XL
9574B	095740102	095740103	095740104	095740105
95740	095740202	095740203	095740204	095740205

Beta

R5C55



**MODULAR
SYSTEM**



**Configure
your workshop
in 3D online**





2024 MOT02
WORLD CHAMPIONSHIP

ALONSO LÓPEZ

FERMÍN ALDEGUER



998016106



8 054809 675121

Beta Tools (UK) Limited | Unit D - Horton Enterprise Park
Hortonwood 50, Telford | Shropshire, TF1 7GZ
Sales: Tel. (01952) 677977

www.beta-tools.co.uk | sales@beta-tools.com